

***fx-570EX***  
***fx-991EX***  
**User's Guide**

CASIO Worldwide Education Website

<http://edu.casio.com>

Be sure to keep all user documentation handy for future reference.

# CONTENTS

About this Manual.....	2
Initializing the Calculator.....	2
Precautions.....	2
Getting Started.....	3
Calculation Mode.....	4
Input and Output Formats.....	5
Configuring the Calculator Setup.....	6
Inputting Expressions and Values.....	8
Toggling Calculation Results.....	10
Basic Calculations.....	10
Calculation History and Replay.....	12
Using Memory Functions.....	13
Function Calculations.....	14
QR Code Function.....	17
Complex Number Calculations.....	18
Using CALC.....	18
Using SOLVE.....	19
Statistical Calculations.....	20
Base- $n$ Calculations.....	23
Equation Calculations.....	24
Matrix Calculations.....	25
Creating a Number Table.....	27
Vector Calculations.....	28
Inequality Calculations.....	29
Ratio Calculations.....	30
Distribution Calculations.....	31
Using Spreadsheet.....	33
Scientific Constants.....	37
Metric Conversion.....	37
Errors.....	37
Before Assuming Malfunction of the Calculator.....	39
Replacing the Battery.....	39
Technical Information.....	40
■■ Frequently Asked Questions ■■.....	42
Reference Sheet.....	44

- In no event shall CASIO Computer Co., Ltd. be liable to anyone for special, collateral, incidental, or consequential damages in connection with or arising out of the purchase or use of this product and items that come with it.
- Moreover, CASIO Computer Co., Ltd. shall not be liable for any claim of any kind whatsoever by any other party arising out of the use of this product and the items that come with it.

## About this Manual

- Unless specifically stated, all sample operations in this manual assume that the calculator is in its initial default setup. Use the procedure under “Initializing the Calculator” to return the calculator to its initial default setup.
- The contents of this manual are subject to change without notice.
- The displays and illustrations (such as key markings) shown in this User's Guide are for illustrative purposes only, and may differ somewhat from the actual items they represent.
- Company and product names used in this manual may be registered trademarks or trademarks of their respective owners.

## Initializing the Calculator

Perform the following procedure when you want to initialize the calculator and return the calculation mode and setup (except for the Contrast setting) to their initial default settings. Note that this operation also clears all data currently in calculator memory.

**SHIFT** **9** (RESET) **3** (Initialize All) **≡** (Yes)

## Precautions

### Safety Precautions



#### Battery

- Keep batteries out of the reach of small children.
- Use only the type of battery specified for this calculator in this manual.

### Handling Precautions

- Even if the calculator is operating normally, replace the battery at least once every three years (LR44) or two years (R03 (UM-4)). A dead battery can leak, causing damage to and malfunction of the calculator. Never leave a dead battery in the calculator. Do not try using the calculator while the battery is completely dead (fx-991EX).
- The battery that comes with the calculator discharges slightly during shipment and storage. Because of this, it may require replacement sooner than the normal expected battery life.
- Avoid use and storage of the calculator in areas subjected to temperature extremes, and large amounts of humidity and dust.
- Do not subject the calculator to excessive impact, pressure, or bending.
- Never try to take the calculator apart.
- Use a soft, dry cloth to clean the exterior of the calculator.
- Whenever discarding the calculator or batteries, be sure to do so in accordance with the laws and regulations in your particular area.

# Getting Started

Before using the calculator, slide its hard case downwards to remove it, and then affix the hard case to the back of the calculator as shown in the illustration nearby.

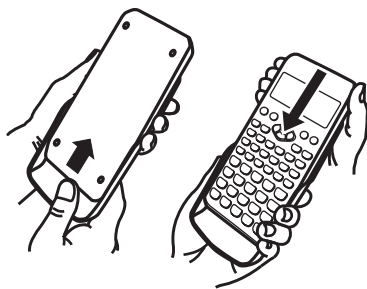

## Turning Power On and Off

Press **ON** to turn on the calculator. Press

**SHIFT AC** (OFF) to turn off the calculator.

**Note:** The calculator also will turn off automatically after approximately 10 minutes of non-use. Press the **ON** key to turn the calculator back on.

## Adjusting Display Contrast

Display the Contrast screen by performing the key operation below:

**SHIFT MENU** (SETUP) **▲** **3** (Contrast). Next, use **◀** and **▶** to adjust contrast.

After the setting is the way you want, press **AC**.

**Important:** If adjusting display contrast does not improve display readability, it probably means that battery power is low. Replace the battery.

## Key Markings

Pressing the **SHIFT** or **ALPHA** key followed by a second key performs the alternate function of the second key. The alternate function is indicated by the text printed above the key.

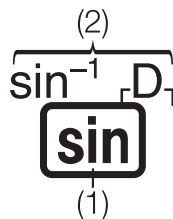

(1) Keycap function (2) Alternate function

This color:	Means this:
Yellow	Press <b>SHIFT</b> and then the key to access the applicable function.
Red	Press <b>ALPHA</b> and then the key to input the applicable variable, constant, function, or symbol.
Purple (or enclosed in purple <b>┌┐</b> brackets)	Enter the Complex Mode to access the function.
Blue (or enclosed in blue <b>┌┐</b> brackets)	Enter the Base-N Mode to access the function.

## Reading the Display

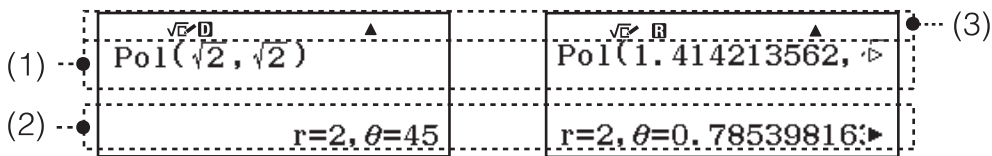

(1) Input expression (2) Calculation result (3) Indicators

- If a **▶** or **▷** indicator appears on the right side of either the input expression line or calculation result line, it means the displayed line continues to the right. Use **▶** and **◀** to scroll the line display. Note that if you want to scroll the input expression while both the **▶** and **▷** indicators are displayed, you will need to press **AC** first and then use **▶** and **◀** to scroll.

- The table below describes some of the typical indicators that appear at the top of the screen.

<b>S</b>	The keypad has been shifted by pressing the <b>SHIFT</b> key. The keypad will unshift and this indicator will disappear when you press a key.
<b>A</b>	The alpha input mode has been entered by pressing the <b>ALPHA</b> key. The alpha input mode will be exited and this indicator will disappear when you press a key.
<b>D/R/G</b>	Indicates the current setting of Angle Unit ( <b>D</b> : Degree, <b>R</b> : Radian, or <b>G</b> : Gradian) on the setup menu.
<b>FIX</b>	A fixed number of decimal places is in effect.
<b>SCI</b>	A fixed number of significant digits is in effect.
<b>M</b>	There is a value stored in independent memory.
<b>→x</b>	The calculator is standing by for input of a variable name to assign a value to the variable. This indicator appears after you press <b>STO</b> .
<b>√□</b>	Indicates that MathI/MathO or MathI/DecimalO is selected for Input/Output on the setup menu.
<b>II</b>	The display currently shows an intermediate result of a multi-statement calculation.
<b>☀</b>	This indicator is displayed while the calculator is being powered directly by its solar cells, either entirely or in some combination with the battery. (fx-991EX only)

## Using Menus

Some of the operations of this calculator are performed using menus.

Menus are displayed by pressing **OPTN** or **SHIFT** and then **MENU** (SETUP).

General menu operation operations are described below.

- You can select a menu item by pressing the number key that corresponds to the number to its left on the menu screen.

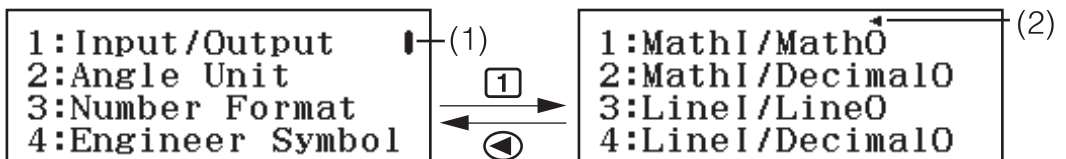









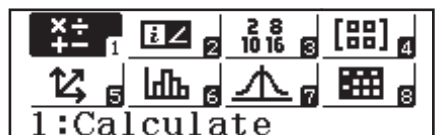

- A vertical scroll bar (1) indicates that the menu runs off the screen. In this case, you can use **▼** and **▲** to scroll the menu up and down. A left arrow (2) indicates that the currently displayed menu is a sub-menu. To return from a sub-menu to its parent menu, press **◀**.
- To close a menu without selecting anything, press **AC**.

## Calculation Mode

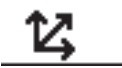
Specify the calculation mode that is suitable for the type of calculation you want to perform.

1. Press **MENU** to display the Main Menu.
2. Use the cursor keys to move the highlighting to the icon you want.

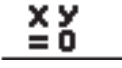
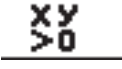



For this:	Select this icon:
General calculations	 (Calculate)
Complex number calculations	 (Complex)
Calculations involving specific number systems (binary, octal, decimal, hexadecimal)	 (Base-N)
Matrix calculations	 (Matrix)
Vector calculations	 (Vector)
Statistical and regression calculations	 (Statistics)
Distribution calculations	 (Distribution)
Spreadsheet calculations	 (Spreadsheet)
Generate a number table based on one or two functions	 (Table)
Equation and function calculations	 (Equation/Func)
Inequality calculations	 (Inequality)
Ratio calculations	 (Ratio)

3. Press  to display the initial screen of the mode whose icon you selected.

**Note:** The initial default calculation mode is the Calculate Mode.

## Input and Output Formats

Before starting a calculation on the calculator, you should first use the operations in the table below to specify the formats that should be applied for calculation formula input and calculation result output.

To specify this type of input and output:	Press   (SETUP) <b>1</b> (Input/Output) and then press:
Input: Natural Textbook; Output: Format that includes a fraction, $\sqrt{\quad}$ , or $\pi^{*1}$	<b>1</b> (MathI/MathO)
Input: Natural Textbook; Output: Converted to decimal value	<b>2</b> (MathI/DecimalO)
Input: Linear <sup>*2</sup> ; Output: Decimal or fraction	<b>3</b> (LineI/LineO)

Input: Linear\*2; Output: Converted to decimal value

**4**(LineI/DecimalO)

\*1 Decimal output is applied when these formats cannot be output for some reason.

\*2 All calculations, including fractions and functions are input in a single line. Same output format as that for models without Natural Textbook Display (S-V.P.A.M. models, etc.)

## Input/Output Format Display Examples

MathI/MathO

$$\frac{4}{5} + \frac{2}{3} = \frac{22}{15}$$

$$\frac{1+\sqrt{2}}{\sqrt{2}} = \frac{2+\sqrt{2}}{2}$$

MathI/DecimalO

$$\frac{4}{5} + \frac{2}{3} = 1.466666667$$

$$\frac{1+\sqrt{2}}{\sqrt{2}} = 1.707106781$$

LineI/LineO

$$4 \div 5 + 2 \div 3 = 22 \div 15$$

$$(1+\sqrt{2}) \div \sqrt{2} = 1.707106781$$

LineI/DecimalO

$$4 \div 5 + 2 \div 3 = 1.466666667$$

$$(1+\sqrt{2}) \div \sqrt{2} = 1.707106781$$

**Note:** The initial default input/output format setting is MathI/MathO.

## Configuring the Calculator Setup

### To change the calculator setup

1. Press **SHIFT** **MENU** (SETUP) to display the setup menu.
2. Use **▼** and **▲** to scroll the setup menu, and then input the number displayed to the left of the item whose setting you want to change.

### Items and Available Setting Options

“♦” indicates the initial default setting.

**Input/Output** **1** MathI/MathO♦; **2** MathI/DecimalO; **3** LineI/LineO; **4** LineI/DecimalO Specifies the format to be used by the calculator for formula input and calculation result output.

**Angle Unit** **1** Degree♦; **2** Radian; **3** Gradian Specifies degree, radian or gradian as the angle unit for value input and calculation result display.

**Number Format** Specifies the number of digits for display of a calculation result.

**1** Fix: The value you specify (from 0 to 9) controls the number of decimal places for displayed calculation results. Calculation results are rounded off to the specified digit before being displayed.

Example:  $100 \div 7$  **SHIFT** **≡** ( $\approx$ )<sup>\*</sup> 14.286 (Fix 3)

**2** Sci: The value you specify (from 0 to 9) controls the number of significant digits for displayed calculation results. Calculation results are rounded off to the specified digit before being displayed.

Example:  $1 \div 7 \text{ [SHIFT] [E] } (\approx)^*$   $1.4286 \times 10^{-1}$  (Sci 5)

**[3] Norm:** Displays calculation results in exponential format when they fall within the ranges below.

**[1] Norm 1\*:**  $10^{-2} > |x|$ ,  $|x| \geq 10^{10}$ , **[2] Norm 2:**  $10^{-9} > |x|$ ,  $|x| \geq 10^{10}$

Example:  $1 \div 200 \text{ [SHIFT] [E] } (\approx)^*$   $5 \times 10^{-3}$  (Norm 1), 0.005 (Norm 2)

\* Pressing **[SHIFT] [E] ( $\approx$ )** instead of **[E]** after inputting a calculation will display the calculation result in decimal form.

---

**Engineer Symbol [1] On; [2] Off\*** Specifies whether or not to display calculation results using engineering symbols.

**Note:** An indicator (E) is displayed at the top of the screen while On is selected for this setting.

---

**Fraction Result [1] ab/c; [2] d/c\*** Specifies either mixed fraction or improper fraction for display of fractions in calculation results.

---

**Complex [1]  $a+bi$ \*; [2]  $r\angle\theta$**  Specifies either rectangular coordinates or polar coordinates for Complex Mode calculation results and Equation/Func Mode solutions.

**Note:** An  $i$  indicator is displayed at the top of the screen while  $a+bi$  is selected for the Complex setting.  $\angle$  is displayed while  $r\angle\theta$  is selected.

---

**Statistics [1] On; [2] Off\*** Specifies whether or not to display a Freq (frequency) column in the Statistics Mode Statistics Editor.

---

**Spreadsheet** For configuring Spreadsheet Mode settings.

**[1] Auto Calc:** Specifies whether or not formulas should be re-calculated automatically.

**[1] On\*;** **[2] Off** Enables or disables auto re-calculation.

**[2] Show Cell:** Specifies whether a formula in the edit box should be displayed as it is or as its calculation result value.

**[1] Formula\*:** Displays the formula as it is.

**[2] Value:** Displays the calculation result value of the formula.

---

**Equation/Func [1] On\*;** **[2] Off** Specifies whether or not to use complex numbers in solutions output in the Equation/Func Mode.

---

**Table [1]  $f(x)$ ; [2]  $f(x),g(x)$ \*** Specifies whether to use function  $f(x)$  only or the two functions  $f(x)$  and  $g(x)$  in the Table Mode.

---

**Decimal Mark [1] Dot\*;** **[2] Comma** Specifies whether to display a dot or a comma for the calculation result decimal mark. A dot is always displayed during input.

**Note:** When dot is selected as the decimal mark, the separator for multiple results is a comma (,). When comma is selected, the separator is a semicolon (;).

---

**Digit Separator [1] On;** **[2] Off\*** Specifies whether or not a separator character should be used in calculation results.

---

**MultiLine Font [1] Normal Font\*;** **[2] Small Font** Specifies the display font size when LineI/LineO or LineI/DecimalO is selected for Input/Output. Up to four lines can be displayed while Normal Font is selected, and up to six lines can be displayed with Small Font.

---

**QR Code** Specifies the version of the QR code displayed when **[SHIFT] [OPTN] (QR)** is pressed.

**[1] Version 3:** Indicates QR code Version 3.

**[2] Version 11\*:** Indicates QR code Version 11.

---

**To initialize calculator settings (except the Contrast setting)**

**[SHIFT] [9] (RESET) [1] (Setup Data) [E] (Yes)**





9	Dot product (•)
10	Multiplication (×), division (÷)
11	Addition (+), subtraction (−)
12	and (logical operator)
13	or, xor, xnor (logical operators)

**Note:** When squaring a negative value (such as -2), the value being squared must be enclosed in parentheses ( $( (-) 2 ) x^2 =$ ). Since  $x^2$  has a higher priority than the negative sign, inputting  $(-) 2 x^2 =$  would result in the squaring of 2 and then appending a negative sign to the result. Always keep the priority sequence in mind, and enclose negative values in parentheses when required.

## Inputting an Expression Using Natural Textbook Format (MathI/MathO or MathI/DecimalO Only)

Formulas and expressions that include fractions and/or special functions such as  $\sqrt{\quad}$  can be input in natural textbook format by using templates that appear when certain keys are pressed.

**Example:**  $3\frac{1}{2} + 5\frac{3}{2}$

1. Press  $\text{SHIFT}$   $\left[ \frac{\square}{\square} \right]$  ( $\frac{\square}{\square}$ ).

- This inputs a mixed fraction template.



2. Input values into the integer, numerator, and denominator areas of the template.

$3 \rightarrow 1 \rightarrow 2$



3. Do the same to input the remainder of the expression.

$\rightarrow + \text{SHIFT} \left[ \frac{\square}{\square} \right] 5 \rightarrow 3 \rightarrow 2 =$

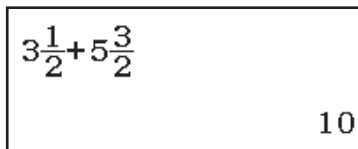

**Tip:** While the input cursor is located within the input area of a template (mixed fractions, integration ( $\int$ ), and sum ( $\Sigma$ )), pressing  $\text{SHIFT}$   $\rightarrow$  jumps to the position immediately following (to the right) of the template, while pressing  $\text{SHIFT}$   $\leftarrow$  jumps to the position immediate before (to the left of) it.



### Note

- When you press  $=$  and obtain a calculation result, part of the expression you input may be cut off. If you need to view the entire input expression again, press  $\text{AC}$  and then use  $\leftarrow$  and  $\rightarrow$  to scroll the input expression.
- Nesting of functions and parentheses is allowed. Further input will become impossible if you nest too many functions and/or parentheses.

**To undo operations (MathI/MathO or MathI/DecimalO only):** To undo the last key operation, press  $\text{ALPHA}$   $\text{DEL}$  (UNDO). To redo a key operation you have just undone, press  $\text{ALPHA}$   $\text{DEL}$  (UNDO) again.

## Using Values and Expressions as Arguments (MathI/MathO or MathI/DecimalO only)

**Example:** To input  $1 + \frac{7}{6}$  and then change it to  $1 + \sqrt{\frac{7}{6}}$

$$1 \boxed{+} 7 \boxed{\frac{\square}{\square}} 6 \leftarrow \leftarrow \leftarrow \leftarrow \boxed{\text{SHIFT}} \boxed{\text{DEL}} (\text{INS}) \quad \boxed{1 + \frac{7}{6}}$$

$$\boxed{\sqrt{\square}} \quad \boxed{1 + \sqrt{\frac{7}{6}}}$$

Pressing  $\boxed{\text{SHIFT}} \boxed{\text{DEL}} (\text{INS})$  in the above example causes  $\frac{7}{6}$  to be the argument of the function input by the next key operation ( $\sqrt{\square}$ ).

## Overwrite Input Mode (LineI/LineO or LineI/DecimalO only)

In the overwrite mode, text you input replaces the text at the current cursor location. You can toggle between the insert and overwrite modes by performing the operations:  $\boxed{\text{SHIFT}} \boxed{\text{DEL}} (\text{INS})$ . The cursor appears as “I” in the insert mode and as “\_” in the overwrite mode.

## toggling Calculation Results

While MathI/MathO or MathI/DecimalO is selected for Input/Output on the setup menu, each press of  $\boxed{\text{S} \leftrightarrow \text{D}}$  will toggle the currently displayed calculation result between its fraction form and decimal form, its  $\sqrt{\square}$  form and decimal form, or its  $\pi$  form and decimal form.

$$\pi \div 6 = \frac{1}{6}\pi = 0.5235987756 \text{ (MathI/MathO)}$$

$$\boxed{\text{SHIFT}} \boxed{\times 10^{\square}} (\pi) \boxed{\div} 6 \boxed{=}$$

$$\frac{1}{6}\pi \leftarrow \boxed{\text{S} \leftrightarrow \text{D}} \rightarrow 0.5235987756$$

$$(\sqrt{2} + 2) \times \sqrt{3} = 5.913591358 = \sqrt{6} + 2\sqrt{3} \text{ (MathI/DecimalO)}$$

$$\boxed{(\square)} \boxed{\sqrt{\square}} 2 \boxed{\rightarrow} \boxed{+} 2 \boxed{)} \boxed{\times} \boxed{\sqrt{\square}} 3 \boxed{=}$$

$$5.913591358 \leftarrow \boxed{\text{S} \leftrightarrow \text{D}} \rightarrow \sqrt{6} + 2\sqrt{3}$$

Regardless of what is selected for Input/Output on the setup menu, each press of  $\boxed{\text{S} \leftrightarrow \text{D}}$  will toggle the currently displayed calculation result between its decimal form and fraction form.

### Important

- With certain calculation results, pressing the  $\boxed{\text{S} \leftrightarrow \text{D}}$  key will not convert the displayed value.
- You cannot switch from decimal form to mixed fraction form if the total number of digits used in the mixed fraction (including integer, numerator, denominator, and separator symbol) is greater than 10.

### To obtain a decimal value calculation result while MathI/MathO or LineI/LineO is selected

Press  $\boxed{\text{SHIFT}} \boxed{=}$  ( $\approx$ ) instead of  $\boxed{=}$  after inputting a calculation.

## Basic Calculations

### Fraction Calculations

Note that the input method for fractions depends on the current Input/Output setting on the setup menu.

$$\frac{2}{3} + 1\frac{1}{2} = \frac{13}{6} \text{ (MathI/MathO)}$$

$$2 \boxed{\frac{\square}{\square}} 3 \boxed{\rightarrow} \boxed{+} \boxed{\text{SHIFT}} \boxed{\frac{\square}{\square}} 1 \boxed{\rightarrow} 1 \boxed{\downarrow} 2 \boxed{=}$$

$$\frac{13}{6}$$

**Note**

- Mixing fractions and decimal values in a calculation while something other than MathI/MathO is selected will cause the result to be displayed as a decimal value.
- Fractions in calculation results are displayed after being reduced to their lowest terms.
- To switch a calculation result between improper fraction and mixed fraction form, press **SHIFT** **S↔D** ( $a\frac{b}{c} \leftrightarrow \frac{d}{c}$ ).

**Percent Calculations**

Inputting a value and pressing **SHIFT** **Ans** (%) causes the input value to become a percent.

$$150 \times 20\% = 30 \quad 150 \times 20 \text{ SHIFT } \text{Ans} (\%) = 30$$

Calculate what percentage of 880 is 660. (75%)

$$660 \div 880 \text{ SHIFT } \text{Ans} (\%) = 75$$

Discount 3500 by 25%. (2625)

$$3500 - 3500 \times 25 \text{ SHIFT } \text{Ans} (\%) = 2625$$

**Degree, Minute, Second (Sexagesimal) Calculations**

The syntax below is for inputting a sexagesimal value: {degrees} **°** {minutes} **'** {seconds} **"**. Note that you must always input something for the degrees and minutes, even if they are zero.

$$2^\circ 20' 30'' + 9^\circ 30'' = 2^\circ 30' 00''$$

$$2 \text{ ° } 20 \text{ ' } 30 \text{ " } + 0 \text{ ° } 9 \text{ ' } 30 \text{ " } = 2^\circ 30' 00''$$

Convert  $2^\circ 30' 00''$  to its decimal equivalent. **°** **'** **"** 2.5  
(Converts decimal to sexagesimal.) **°** **'** **"**  $2^\circ 30' 00''$

**Multi-Statements**

You can use the colon character (:) to connect two or more expressions and execute them in sequence from left to right when you press **=**.

$$3 + 3 : 3 \times 3 \quad 3 + 3 \text{ ALPHA } \text{I/O} (:) 3 \times 3 = 6$$

$$9$$

**Note:** Inputting a colon (:) while LineI/LineO or LineI/DecimalO is selected for the Input/Output setting on the setup menu causes a newline operation to be performed.

**Using Engineering Notation**

Transform the value 1234 to engineering notation, shifting the decimal mark to the right, and then to the left.

$$1234 \text{ ENG} = 1234$$

$$\text{ENG} = 1.234 \times 10^3$$

$$\text{ENG} = 1234 \times 10^0$$

$$\text{SHIFT } \text{ENG} (\leftarrow) = 1.234 \times 10^3$$

$$\text{SHIFT } \text{ENG} (\leftarrow) = 0.001234 \times 10^6$$

**Note:** The calculation result shown above is what appears when Off is selected for the Engineer Symbol setting on the setup menu.

**Using Engineering Symbols**

Your calculator supports the use of 11 engineering symbols (m,  $\mu$ , n, p, f, k, M, G, T, P, E) that you can use for input of value or for calculation result display.

**To display calculation results with engineering symbols**

On the setup menu, change the Engineer Symbol setting to On.

## Example Input and Calculations Using Engineering Symbols

To input 500k

500 **OPTN** **3** (Engineer Symbol)

1:m	2:μ	3:n
4:p	5:f	6:k
7:M	8:G	9:T
A:P	B:E	

**6**(k) **≡**

500k

To calculate 999k (kilo) + 25k (kilo) = 1.024M (Mega) = 1024k (kilo) = 1024000

999 **OPTN** **3** (Engineer Symbol) **6**(k) **+**

25 **OPTN** **3** (Engineer Symbol) **6**(k) **≡**

1.024M

**ENG**

1024k

**ENG**

1024000

**SHIFT** **ENG** (←)

1024k

## Prime Factorization

In the Calculate Mode, a positive integer no more than 10 digits long can be factored to prime factors.

To perform prime factorization on 1014

1014 **≡**

1014

**SHIFT** **0.999** (FACT)

$2 \times 3 \times 13^2$

To re-display the unfactored value, press **SHIFT** **0.999** (FACT) or **≡**.

**Note:** The types of values described below cannot be factored, even if they have 10 or fewer digits.

- One of the prime factors of the value is 1,018,081 or greater.
- Two or more of the prime factors of the value have more than three digits.

The part that cannot be factored will be enclosed in parentheses on the display.

## Calculation History and Replay

### Calculation History

An ▲ and/or ▼ at the top of the display indicates that there is more calculation history content above and/or below. You can scroll through calculation history contents using ▲ and ▼.

2 + 2 = 4

2 **+** 2 **≡**

4

3 + 3 = 6

3 **+** 3 **≡**

6

(Scrolls back.) ▲

4

**Note:** Calculation history data is all cleared whenever you press **ON**, when you change to a different calculation mode, when you change the Input/Output setting, or whenever you perform a RESET operation (“Initialize All” or “Setup Data”).

### Replay

While a calculation result is on the display, you can press ◀ or ▶ to edit the expression you used for the previous calculation.

4 × 3 + 2 = 14

4 **×** 3 **+** 2 **≡**

14

4 × 3 - 7 = 5

(Continuing) ◀ **DEL** **DEL** **-** 7 **≡**

5

# Using Memory Functions

## Answer Memory (Ans)

The last calculation result obtained is stored in Ans (answer) memory.

To divide the result of  $14 \times 13$  by 7

$$14 \times 13 = 182$$

(Continuing)  $\div 7 =$

Ans $\div$ 7
26

$$123 + 456 = 579$$

$$123 + 456 = 579$$

$$789 - 579 = 210$$

(Continuing)  $789 - \text{Ans} = 210$

## Variables (A, B, C, D, E, F, M, x, y)

You can assign values to variables and use the variables in calculations.

To assign the result of  $3 + 5$  to variable A

$$3 + 5 \text{ STO } (A) = 8$$

To multiply the contents of variable A by 10

(Continuing)  $\text{ALPHA } (A) \times 10 = 80$

To recall the contents of variable A

(Continuing)  $\text{SHIFT } \text{STO} (\text{RECALL})^{*2}$

A=8	B=J(2)
C=3.14159265	D=0.42857142
E=1.3	F=J(7)
M=7.2115 $\times 10^{10}$	x=7.3
y=2° 15' 18"	

$$(A) = 8$$

To clear the contents of variable A

$$0 \text{ STO } (A) = 0$$

\*1 Input a variable as shown here: press  $\text{ALPHA}$  and then press the key that corresponds to the desired variable name. To input  $x$  as the variable name, you can press  $\text{ALPHA } (x)$  or  $x$ .

\*2 Pressing  $\text{SHIFT } \text{STO} (\text{RECALL})$  displays a screen that shows the values currently assigned to variables A, B, C, D, E, F, M, x, and y. On this screen, values are always displayed using the "Norm 1" Number Format. To close the screen without recalling a variable value, press  $\text{AC}$ .

## Independent Memory (M)

You can add calculation results to or subtract results from independent memory. The "M" appears on the display when there is any value other than zero stored in independent memory.

To clear the contents of M

$$0 \text{ STO } \text{M+} (M) = 0$$

To add the result of  $10 \times 5$  to M

(Continuing)  $10 \times 5 \text{ M+} = 50$

To subtract the result of  $10 + 5$  from M

(Continuing)  $10 + 5 \text{ SHIFT } \text{M+} (M-) = 15$

To recall the contents of M

(Continuing)  $\text{SHIFT } \text{STO} (\text{RECALL}) \text{M+} (M) = 35$

**Note:** Variable M is used for independent memory. You also can call M and use it in a calculation you are inputting.

## Clearing the Contents of All Memories

Ans memory, independent memory, and variable contents are retained even if you press **AC**, change the calculation mode, or turn off the calculator. Perform the procedure below when you want to clear the contents of all memories.

**SHIFT** **9** (RESET) **2** (Memory) **≡** (Yes)

## Function Calculations

**Note:** To interrupt an ongoing calculation before its result appears, press **AC**.

**Pi  $\pi$ :**  $\pi$  is displayed as 3.141592654, but  $\pi = 3.14159265358980$  is used for internal calculations.

**Natural Logarithm Base  $e$ :**  $e$  is displayed as 2.718281828, but  $e = 2.71828182845904$  is used for internal calculations.

**sin, cos, tan,  $\sin^{-1}$ ,  $\cos^{-1}$ ,  $\tan^{-1}$ :** Specify the angle unit before performing calculations.

$\sin 30^\circ = \frac{1}{2}$  (Angle Unit: Degree) **sin** 30 **)** **≡**  $\frac{1}{2}$

**sinh, cosh, tanh,  $\sinh^{-1}$ ,  $\cosh^{-1}$ ,  $\tanh^{-1}$ :** Input a function from the menu that appears when you press **OPTN** **1** (Hyperbolic Func)\*1. The angle unit setting does not affect calculations.

\*1 Depending on the calculation mode, you should press **OPTN** **▲** **1**.

**°,  $r$ ,  $g$ :** These functions specify the angle unit.  $^\circ$  specifies degree,  $r$  radian, and  $g$  gradian. Input a function from the menu that appears when you perform the following key operation: **OPTN** **2** (Angle Unit)\*2.

$\pi/2$  radians =  $90^\circ$  (Angle Unit: Degree)

**(** **SHIFT** **x10<sup>3</sup>** **( $\pi$ )** **÷** **2** **)** **OPTN** **2** (Angle Unit) **2** ( $r$ ) **≡** 90

\*2 Depending on the calculation mode, you should press **OPTN** **▲** **2**.

**$10^{\square}$ ,  $e^{\square}$ :** Exponential functions.

$e^5 \times 2 = 296.8263182$

(MathI/MathO) **SHIFT** **In** ( $e^{\square}$ ) 5 **▶** **×** 2 **≡** 296.8263182

(LineI/LineO) **SHIFT** **In** ( $e^{\square}$ ) 5 **)** **×** 2 **≡** 296.8263182

**log:** Logarithmic function. Use **SHIFT** **( $\leftarrow$ )** (log) to input  $\log_a b$  as  $\log(a, b)$ .

Base 10 is the default setting if you do not input anything for  $a$ .

$\log_{10} 1000 = \log 1000 = 3$  **SHIFT** **( $\leftarrow$ )** (log) 1000 **)** **≡** 3

$\log_2 16 = 4$  **SHIFT** **( $\leftarrow$ )** (log) 2 **SHIFT** **)** (,) 16 **)** **≡** 4

The **log<sub>a</sub>** key also can be used for input, but only while MathI/MathO or MathI/DecimalO is selected for Input/Output on the setup menu. In this case, you must input a value for the base.

$\log_2 16 = 4$  **log<sub>a</sub>** 2 **▶** 16 **≡** 4

**In:** Natural logarithm to base  $e$ .

$\ln 90 (= \log_e 90) = 4.49980967$  **In** 90 **)** **≡** 4.49980967

**$x^2$ ,  $x^3$ ,  $x^{\square}$ ,  $\sqrt{\square}$ ,  $\sqrt[3]{\square}$ ,  $\sqrt[n]{\square}$ ,  $x^{-1}$ :** Powers, power roots, and reciprocals.

$(1 + 1)^{2+2} = 16$  **(** 1 **+** 1 **)** **x<sup>□</sup>** 2 **+** 2 **≡** 16

$(5^2)^3 = 15625$  **(** 5 **x<sup>2</sup>** **)** **SHIFT** **x<sup>2</sup>** ( $x^3$ ) **≡** 15625

$\sqrt[5]{32} = 2$  (MathI/MathO) **SHIFT** **x<sup>□</sup>** ( $\sqrt[n]{\square}$ ) 5 **▶** 32 **≡** 2

(Line/LineO)  $5 \text{ [SHIFT] } [x^2] (\sqrt{\square}) 32 \text{ [)] [=]$  2

$$\sqrt{2} \times 3 = 3\sqrt{2} = 4.242640687\dots$$

(MathI/MathO)  $\text{[2] [2] [x^2] [3] [=]$   $3\sqrt{2}$

(Line/LineO)  $\text{[2] [)] [x^2] [3] [=]$  4.242640687

$\int_{\square}^{\square}$ ,  $\frac{d}{dx}$ ,  $\sum_{\square}^{\square}$ : These functions use Gauss-Kronrod methods to perform numerical integration, approximation of the derivative based on central difference method, and calculation of the sum of a specific range of  $f(x)$ .

### Input Syntax

(1) When MathI/MathO or MathI/DecimalO is selected

(2) When Line/LineO or Line/DecimalO is selected

	$\int_{\square}^{\square} *1$	$\frac{d}{dx} *2$	$\sum_{\square}^{\square} *3$
(1)	$\int_a^b f(x) dx$	$\left. \frac{d}{dx} (f(x)) \right _{x=a}$	$\sum_{x=a}^b (f(x))$
(2)	$\int (f(x), a, b, tol)$	$\frac{d}{dx} (f(x), a, tol)$	$\sum (f(x), a, b)$

\*1  $tol$  specifies tolerance, which becomes  $1 \times 10^{-5}$  when nothing is input for  $tol$ .

\*2  $tol$  specifies tolerance, which becomes  $1 \times 10^{-10}$  when nothing is input for  $tol$ .

\*3  $a$  and  $b$  are integers that can be specified within the range of  $-1 \times 10^{10} < a \leq b < 1 \times 10^{10}$ .

### Integration and Differential Calculation Precautions

- When using a trigonometric function in  $f(x)$ , specify “Radian” as the angle unit.
- A smaller  $tol$  value increases precision, but it also increases calculation time. When specifying  $tol$ , use value that is  $1 \times 10^{-14}$  or greater.
- Integration normally requires considerable time to perform.
- Depending on the content of  $f(x)$ , positive and negative values within the region of integration, or the region of integration, calculation error that exceeds the allowable range may be generated, causing the calculator to display an error message.
- With derivative calculations, non-consecutive points, abrupt fluctuation, extremely large or small points, inflection points, and the inclusion of points that cannot be differentiated, or a differential point or a differential calculation result that approaches zero can cause poor precision or error.

$$\int_1^e \ln(x) dx$$

(MathI/MathO)  $\text{[∫] [ln] [ALPHA] [)] (x) [)] [2] [1] [2] [ALPHA] [x10^x] (e) [=]$  1

(Line/LineO)  $\text{[∫] [ln] [ALPHA] [)] (x) [)] [SHIFT] [)] (,)$

$1 \text{ [SHIFT] [)] (, [ALPHA] [x10^x] (e) [)] [=]$  1

To obtain the derivative at point  $x = \pi/2$  for the function  $y = \sin(x)$  (Angle Unit: Radian)

$$\text{[SHIFT] [∫] (} \frac{d}{dx} \text{) [sin] [ALPHA] [)] (x) [)] \dots (1)$$

(MathI/MathO) (Continued following (1))  $\text{[2] [=] [SHIFT] [x10^x] (\pi) [2] [=]$  0

(Line/LineO) (Continued following (1))  $\text{[SHIFT] [)] (, [SHIFT] [x10^x] (\pi) [=] [2] [)] [=]$  0

(Continued following (1))  $\text{[SHIFT] [)] (, [SHIFT] [x10^x] (\pi) [=] [2] [)] [=]$  0

(Continued following (1))  $\text{[SHIFT] [)] (, [SHIFT] [x10^x] (\pi) [=] [2] [)] [=]$  0

$$\sum_{x=1}^5 (x+1) = 20$$



(MathI/MathO)  $\text{SHIFT} \text{X} (\Sigma^-) \text{ALPHA} \text{)} (x) \text{+} 1 \text{▶} 1 \text{▶} 5 \text{=}$  20

(LineI/LineO)  $\text{SHIFT} \text{X} (\Sigma^-) \text{ALPHA} \text{)} (x) \text{+} 1$   
 $\text{SHIFT} \text{)} (,) 1 \text{SHIFT} \text{)} (,) 5 \text{)} \text{=}$  20

**Pol, Rec:** Pol converts rectangular coordinates to polar coordinates, while Rec converts polar coordinates to rectangular coordinates.

- Specify the angle unit before performing calculations.
- The calculation result for  $r$  and  $\theta$  and for  $x$  and  $y$  are each assigned respectively to variables  $x$  and  $y$ .
- Calculation result  $\theta$  is displayed in the range of  $-180^\circ < \theta \leq 180^\circ$ .

$$\text{Pol}(x, y) = (r, \theta) \qquad \text{Rec}(r, \theta) = (x, y)$$

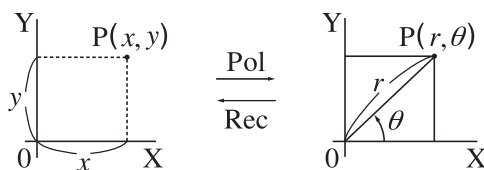

To convert rectangular coordinates  $(\sqrt{2}, \sqrt{2})$  to polar coordinates (Angle Unit: Degree)

(MathI/MathO)  $\text{SHIFT} \text{+} (\text{Pol}) \sqrt{2} \text{▶} \text{SHIFT} \text{)} (,) \sqrt{2} \text{▶} \text{)} \text{=}$   $r=2, \theta=45$

To convert polar coordinates  $(\sqrt{2}, 45^\circ)$  to rectangular coordinates (Angle Unit: Degree)

(MathI/MathO)  $\text{SHIFT} \text{-} (\text{Rec}) \sqrt{2} \text{▶} \text{SHIFT} \text{)} (,) 45 \text{)} \text{=}$   $x=1, y=1$

**x!:** Factorial function.

$(5 + 3) ! = 40320$   $\text{)} (5 \text{+} 3 \text{)} \text{SHIFT} \text{x} (x!) \text{=}$  40320

**Abs:** Absolute value function.

$$|2 - 7| \times 2 = 10$$

(MathI/MathO)  $\text{SHIFT} \text{)} ( \text{Abs} ) 2 \text{-} 7 \text{▶} \text{x} 2 \text{=}$  10

(LineI/LineO)  $\text{SHIFT} \text{)} ( \text{Abs} ) 2 \text{-} 7 \text{)} \text{x} 2 \text{=}$  10

**Ran#:** Function that generates a pseudo random number in the range of 0.000 to 0.999. The result is displayed as a fraction when MathI/MathO is selected for Input/Output on the setup menu.

To obtain random three-digit integers

$1000 \text{SHIFT} \text{.} (\text{Ran\#}) \text{=}$  459

(The result differs with each execution.)

**RanInt#:** Function that generates a pseudo random integer between a specified start value and end value.

To generate random integers in the range of 1 to 6

$\text{ALPHA} \text{.} (\text{RanInt}) 1 \text{SHIFT} \text{)} (,) 6 \text{)} \text{=}$  2

(The result differs with each execution.)

**nPr, nCr:** Permutation ( $nPr$ ) and combination ( $nCr$ ) functions.

To determine the number of permutations and combinations possible when selecting four people from a group of 10

Permutations:  $10 \text{SHIFT} \text{x} (nPr) 4 \text{=}$  5040

Combinations:  $10 \text{SHIFT} \text{\div} (nCr) 4 \text{=}$  210

**Rnd:** Using the Rnd function causes decimal fraction values of the argument to be rounded in accordance with the current Number Format setting. For example, the internal and displayed result of  $\text{Rnd}(10 \div 3)$  is 3.333 when the Number Format setting is Fix 3. Using the Norm 1 or Norm 2 setting cause the argument to be rounded off at the 11th digit of the mantissa part.

To perform the following calculations when Fix 3 is selected for the number of display digits:  $10 \div 3 \times 3$  and  $\text{Rnd}(10 \div 3) \times 3$  (MathI/DecimalO)

$\text{SHIFT} \text{MENU} (\text{SETUP}) \text{3} (\text{Number Format}) \text{1} (\text{Fix}) \text{3}$

## QR Code Function

Your calculator can display QR codes\* that can be read by a smart device.  
 \* QR Code is a registered trademark of DENSO WAVE INCORPORATED in Japan and in other countries.

### Important

- The operations in this section assume that the smart device being used has a QR code reader that can read multiple QR codes installed, and it can connect to the Internet.
- Reading a QR code displayed by this calculator with a smart device will cause the smart device to access the CASIO website.

**Note:** A QR code can be displayed by pressing  $\text{SHIFT}$   $\text{OPTN}$  (QR) while the setup screen, a menu screen, an error screen, a calculation result screen in any calculation mode, or a table screen is displayed. For details, visit the CASIO website (wes.casio.com).

## Displaying a QR Code

**Example:** To display the QR code for a calculation result in the calculator's Calculate Mode and read it with a smart device

1. In the Calculate Mode, execute some calculation.
2. Press  $\text{SHIFT}$   $\text{OPTN}$  (QR) to display the QR code.

- The numbers in the lower right corner of the display shows the current QR code number and the total number of QR codes. To display the next QR code, press  $\blacktriangledown$  or  $\equiv$ .



### Note

- A  $\text{II}$  indicator is displayed at the top of the screen while the calculator is generating a QR code.
  - To return to a previous QR code, press  $\blacktriangledown$  or  $\equiv$  as many times as required to scroll forward until it appears.
3. Use a smart device to read the QR code on the calculator display.
    - For information about how to read a QR code, refer to the user documentation of the QR code reader you are using.

**If you experience difficulty reading a QR code:** While the QR code is displayed use  $\blacktriangleleft$  and  $\blacktriangleright$  to adjust the display contrast of the QR code. This contrast adjustment affects QR code displays only.

### Important

- Depending on the smart device and/or QR reader app being used, you may experience problems reading the QR codes produced by this calculator.
- When the setup "QR Code" setting is "Version 3", the calculator modes that can display QR codes are limited. If you try to display a QR code in a mode that does not support QR code display, the message "Not Supported (Version 3)" will appear. However, the QR code produced by this setting is easier to read with a smart device.
- For more information, visit the CASIO website (wes.casio.com).

**To exit the QR code display:** Press  $\text{AC}$  or  $\text{SHIFT}$   $\text{OPTN}$  (QR).

## Complex Number Calculations

To perform complex number calculations, first enter the Complex Mode. You can use either rectangular coordinates ( $a+bi$ ) or polar coordinates ( $r\angle\theta$ ) to input complex numbers. Complex number calculation results are displayed in accordance with the Complex setting on the setup menu.

$$(1+i)^4 + (1-i)^2 = -4 - 2i \quad (\text{Complex: } a+bi)^*$$

$\boxed{1} \boxed{+} \boxed{\text{ENG}} \boxed{(i)} \boxed{)} \boxed{x^4} \boxed{\blacktriangleright} \boxed{+} \boxed{1} \boxed{-} \boxed{\text{ENG}} \boxed{(i)} \boxed{)} \boxed{x^2} \boxed{=}$ 
-4 - 2i

$$2\angle 45 = \sqrt{2} + \sqrt{2}i \quad (\text{Angle Unit: Degree, Complex: } a+bi)$$

$2 \boxed{\text{SHIFT}} \boxed{\text{ENG}} \boxed{(\angle)} 45 \boxed{=}$ 
 $\sqrt{2} + \sqrt{2}i$

$$\sqrt{2} + \sqrt{2}i = 2\angle 45 \quad (\text{Angle Unit: Degree, Complex: } r\angle\theta)$$

$\boxed{\sqrt{2}} \boxed{2} \boxed{\blacktriangleright} \boxed{+} \boxed{\sqrt{2}} \boxed{2} \boxed{\blacktriangleright} \boxed{\text{ENG}} \boxed{(i)} \boxed{=}$ 
2∠45

\* When raising a complex number to an integer power using the syntax  $(a+bi)^n$ , the power value can be within the following range:  $-1 \times 10^{10} < n < 1 \times 10^{10}$ .

### Note

- If you are planning to perform input and display of the calculation result in polar coordinate format, specify the angle unit before starting the calculation.
- The  $\theta$  value of the calculation result is displayed in the range of  $-180^\circ < \theta \leq 180^\circ$ .
- Display of the calculation result while Linel/LineO or Linel/DecimalO is selected will show  $a$  and  $bi$  (or  $r$  and  $\theta$ ) on separate lines.

## Complex Mode Calculation Examples

To obtain the conjugate complex number of  $2 + 3i$  (Complex:  $a+bi$ )

$\boxed{\text{OPTN}} \boxed{2} \text{ (Conjugate)} \boxed{2} \boxed{+} \boxed{3} \boxed{\text{ENG}} \boxed{(i)} \boxed{)} \boxed{=}$ 
2-3i

To obtain the absolute value and argument of  $1 + i$  (Angle Unit: Degree)

$\boxed{\text{SHIFT}} \boxed{1} \text{ (Abs)} \boxed{1} \boxed{+} \boxed{\text{ENG}} \boxed{(i)} \boxed{=}$ 
 $\sqrt{2}$

$\boxed{\text{OPTN}} \boxed{1} \text{ (Argument)} \boxed{1} \boxed{+} \boxed{\text{ENG}} \boxed{(i)} \boxed{)} \boxed{=}$ 
45

To extract the real part and imaginary part of  $2 + 3i$

$\boxed{\text{OPTN}} \boxed{3} \text{ (Real Part)} \boxed{2} \boxed{+} \boxed{3} \boxed{\text{ENG}} \boxed{(i)} \boxed{)} \boxed{=}$ 
2

$\boxed{\text{OPTN}} \boxed{4} \text{ (Imaginary Part)} \boxed{2} \boxed{+} \boxed{3} \boxed{\text{ENG}} \boxed{(i)} \boxed{)} \boxed{=}$ 
3

## Using a Command to Specify the Calculation Output Format

$$\sqrt{2} + \sqrt{2}i = 2\angle 45, \quad 2\angle 45 = \sqrt{2} + \sqrt{2}i \quad (\text{Angle Unit: Degree})$$

$\boxed{\sqrt{2}} \boxed{2} \boxed{\blacktriangleright} \boxed{+} \boxed{\sqrt{2}} \boxed{2} \boxed{\blacktriangleright} \boxed{\text{ENG}} \boxed{(i)} \boxed{\text{OPTN}} \boxed{\blacktriangledown} \boxed{1} \text{ (} \blacktriangleright r\angle\theta \text{)} \boxed{=}$ 
2∠45

$2 \boxed{\text{SHIFT}} \boxed{\text{ENG}} \boxed{(\angle)} 45 \boxed{\text{OPTN}} \boxed{\blacktriangledown} \boxed{2} \text{ (} \blacktriangleright a+bi \text{)} \boxed{=}$ 
 $\sqrt{2} + \sqrt{2}i$

## Using CALC

CALC lets you input calculation expressions that include one or more variable, assign values to the variables, and calculate the result. CALC can be used in the Calculate Mode and Complex Mode.

You can use CALC to save the types of expressions below.

- $2x + 3y$ ,  $2Ax + 3By + C$ ,  $A + Bi$ , etc.
- $x + y : x(x + y)$ , etc.
- $y = x^2 + x + 3$ , etc.

**Note:** During the time from when you press  $\boxed{\text{CALC}}$  until you exit CALC by pressing  $\boxed{\text{AC}}$ , you should use Linear input procedures for input.

To store  $3A + B$  and then substitute the following values to perform the calculation:  $A = 5, B = 10$

$3$   $\alpha$   $(\leftarrow)$   $(A)$   $+$   $\alpha$   $(\rightarrow)$   $(B)$

$\text{CALC}$   $5$   $\text{=}$   $10$   $\text{=}$   $\text{=}$

$3A+B$   
 $A = 0$

$3A+B$   
 $25$

## Using SOLVE

SOLVE uses Newton's method to approximate the solution of equations. Note that SOLVE can be used in the Calculate Mode only. SOLVE supports input of equations of the following formats.

Examples:  $y = x + 5$ ,  $x = \sin(M)$ ,  $xy + C$  (Treated as  $xy + C = 0$ )

### Note

- If an equation contains input functions that include an open parenthesis (such as sin and log), do not omit the closing parenthesis.
- During the time from when you press  $\text{SHIFT}$   $\text{CALC}$  (SOLVE) until you exit SOLVE by pressing  $\text{AC}$ , you should use Linear input procedures for input.

To solve  $x^2 + b = 0$  for  $x$  when  $b = -2$

$\alpha$   $( )$   $(x)$   $x^2$   $+$   $\alpha$   $(\rightarrow)$   $(B)$   $\alpha$   $\text{CALC}$   $(=)$   $0$

$\text{SHIFT}$   $\text{CALC}$  (SOLVE)

Input an initial value for  $x$  (Here,  $1$   $\text{=}$  input 1):

Assign  $-2$  to  $B$ :  $(\leftarrow)$   $2$   $\text{=}$

Specify the variable you want to solve for (Here we want to solve for  $x$ , so move the highlighting to  $x$ ):

$\uparrow$

Solve the equation:

$\text{=}$

(1) Variable solved for  
 (2) Solution  
 (3) (Left Side) – (Right Side) result

$x^2 + B = 0$   
 $x^2 + B = 0$   
 $B = -2$   
 $x^2 + B = 0$   
 $x = 1$   
 $x^2 + B = 0$   
 $x = 1.414213562$   
 $L-R = 0$

(1) (2) (3)

- Solutions are always displayed in decimal form.
- The closer the (Left Side) – (Right Side) result is to zero, the higher the accuracy of the solution.

### Important

- SOLVE performs convergence a preset number of times. If it cannot find a solution, it displays a confirmation screen that shows "Continue:[=]", asking if you want to continue. Press  $\text{=}$  to continue or  $\text{AC}$  to cancel the SOLVE operation.
- Depending on what you input for the initial value for  $x$  (solution variable), SOLVE may not be able to obtain solutions. If this happens, try changing the initial value so they are closer to the solution.
- SOLVE may not be able to determine the correct solution, even when one exists.

- SOLVE uses Newton's method, so even if there are multiple solutions, only one of them will be returned.
- Due to limitations in Newton's method, solutions tend to be difficult to obtain for equations like the following:  $y = \sin x$ ,  $y = e^x$ ,  $y = \sqrt{x}$ .

## Statistical Calculations

Perform the steps below to start a statistical calculation.

1. Press **MENU**, select the Statistics Mode icon, and then press **≡**.
2. On the Select Type screen that appears, select a statistical calculation type.

To select this type of statistical calculation:	Press this key:
Single-variable ( $x$ )	<b>1</b> (1-Variable)
Paired-variable ( $x, y$ ), linear regression	<b>2</b> ( $y=a+bx$ )
Paired-variable ( $x, y$ ), quadratic regression	<b>3</b> ( $y=a+bx+cx^2$ )
Paired-variable ( $x, y$ ), logarithmic regression	<b>4</b> ( $y=a+b \cdot \ln(x)$ )
Paired-variable ( $x, y$ ), $e$ exponential regression	<b>▼ 1</b> ( $y=a \cdot e^{(bx)}$ )
Paired-variable ( $x, y$ ), $ab$ exponential regression	<b>▼ 2</b> ( $y=a \cdot b^x$ )
Paired-variable ( $x, y$ ), power regression	<b>▼ 3</b> ( $y=a \cdot x^b$ )
Paired-variable ( $x, y$ ), inverse regression	<b>▼ 4</b> ( $y=a+b/x$ )

- Performing any of the above key operations displays the Statistics Editor.

**Note:** When you want to change the calculation type after entering the Statistics Mode, perform the key operation **OPTN 1** (Select Type) to display the calculation type selection screen.

## Inputting Data with Statistics Editor

Statistics Editor displays one, two, or three columns: single-variable ( $x$ ), single variable and frequency ( $x$ , Freq), paired-variable ( $x, y$ ), paired-variable and frequency ( $x, y$ , Freq). The number of data rows that can be input depends on the number of columns: 160 rows for one column, 80 rows for two columns, 53 rows for three columns.

### Note

- Use the Freq (frequency) column to input the quantity (frequency) of identical data items. Display of the Freq column can be turned on (displayed) or off (not displayed) using the Statistics setting on the setup menu.
- Pressing the **AC** key while the Statistics Editor is on the screen will display a statistical calculation screen for performing calculations based on the input data. What you need to do to return to the Statistics Editor from the statistical calculation screen depends on the calculation type you selected. Press **OPTN 3** (Data) if you selected single-variable or **OPTN 4** (Data) if you selected paired-variable.

**Ex 1:** To select logarithmic regression and input the following data: (170, 66), (173, 68), (179, 75)

**OPTN 1** (Select Type) **4** ( $y=a+b \cdot \ln(x)$ )

	$x$	$y$	
1			
2			
3			

170  $\square$  173  $\square$  179  $\square$   $\blacktriangledown$   $\blacktriangleright$   
 66  $\square$  68  $\square$  75  $\square$

	x	y
1	170	66
2	173	68
3	179	75
4		

**Important:** All data currently input in the Statistics Editor is deleted whenever you exit the Statistics Mode, switch between the single-variable and a paired-variable statistical calculation type, or change the Statistics setting on the setup menu.

**To delete a line:** In the Statistics Editor, move the cursor to the line that you want to delete and then press  $\square$ .

**To insert a line:** In the Statistics Editor, move the cursor to the location where you want to insert the line and then perform the following key operation:  $\square$   $\square$  (Editor)  $\square$  (Insert Row).

**To delete all Statistics Editor contents:** In the Statistics Editor, perform the following key operation:  $\square$   $\square$  (Editor)  $\square$  (Delete All).

## Displaying Statistical Values Based On Input Data

From the Statistics Editor:

$\square$   $\square$  (1-Variable Calc or 2-Variable Calc)

From the statistical calculation screen:

$\square$   $\square$  (1-Variable Calc or 2-Variable Calc)

$\bar{x}$	=174
$\Sigma x$	=522
$\Sigma x^2$	=90870
$\sigma^2 x$	=14
$\sigma x$	=3.741657387
$s^2 x$	=21

## Displaying Regression Calculation Results Based On Input Data (Paired-Variable Data Only)

From the Statistics Editor:

$\square$   $\square$  (Regression Calc)

From the statistical calculation screen:

$\square$   $\square$  (Regression Calc)

$y=a+b \cdot \ln(x)$
$a=-852.1627746$
$b=178.6897969$
$r=0.9919863213$

## Obtaining Statistical Values from Input Data

You can use the operations in this section to recall statistical values assigned to variables ( $\sigma_x$ ,  $\Sigma x^2$ , etc.) based on the data you input with the Statistics Editor. You can also use the variables in calculations. The operations in this section are performed on the statistical calculation screen that appears when you press  $\square$  while the Statistics Editor is displayed. Supported statistical variables and the keys you should press to recall them are shown below. For single-variable statistical calculations, the variables marked with an asterisk (\*) are available.

**Summation:**  $\Sigma x^*$ ,  $\Sigma x^{2*}$ ,  $\Sigma y$ ,  $\Sigma y^2$ ,  $\Sigma xy$ ,  $\Sigma x^3$ ,  $\Sigma x^2y$ ,  $\Sigma x^4$

$\square$   $\blacktriangledown$   $\square$  (Summation)  $\square$  to  $\square$

**Number of Items:**  $n^*$  / **Mean:**  $\bar{x}^*$ ,  $\bar{y}$  / **Population Variance:**  $\sigma_x^{2*}$ ,  $\sigma_y^2$  /

**Population Standard Deviation:**  $\sigma_x^*$ ,  $\sigma_y$  / **Sample Variance:**  $s_x^{2*}$ ,  $s_y^2$  /

**Sample Standard Deviation:**  $s_x^*$ ,  $s_y$

$\square$   $\blacktriangledown$   $\square$  (Variable)  $\square$  to  $\square$ ,  $\blacktriangledown$   $\square$  to  $\blacktriangledown$   $\square$

**Minimum Value:**  $\min(x)^*$ ,  $\min(y)$  / **Maximum Value:**  $\max(x)^*$ ,  $\max(y)$

When the single-variable statistical calculation is selected:

$\square$   $\blacktriangledown$   $\square$  (Min/Max)  $\square$ ,  $\square$

When a paired-variable statistical calculation is selected:

$\square$   $\blacktriangledown$   $\square$  (Min/Max)  $\square$  to  $\square$

**First Quartile:**  $Q_1^*$  / **Median:**  $\text{Med}^*$  / **Third Quartile:**  $Q_3^*$  (For single-variable statistical calculations only)

$\square$   $\blacktriangledown$   $\square$  (Min/Max)  $\square$  to  $\square$

**Regression Coefficients:  $a, b$  / Correlation Coefficient:  $r$  / Estimated Values:  $\hat{x}, \hat{y}$**

**OPTN** **▼** **4** (Regression) **1** to **5**

**Regression Coefficients for Quadratic Regression:  $a, b, c$  / Estimated Values:  $\hat{x}_1, \hat{x}_2, \hat{y}$**

**OPTN** **▼** **4** (Regression) **1** to **6**

- $\hat{x}, \hat{x}_1, \hat{x}_2$  and  $\hat{y}$  are commands of the type that take an argument immediately before them.

**Ex 2:** To input the single-variable data  $x = \{1, 2, 2, 3, 3, 3, 4, 4, 5\}$ , using the Freq column to specify the number of repeats for each items  $\{x_n; \text{freq}_n\} = \{1;1, 2;2, 3;3, 4;2, 5;1\}$ , and calculate the mean.

**SHIFT** **MENU** (SETUP) **▼** **3** (Statistics) **1** (On)

**OPTN** **1** (Select Type) **1** (1-Variable)

1 **≡** 2 **≡** 3 **≡** 4 **≡** 5 **≡** **▼** **▶**  
1 **≡** 2 **≡** 3 **≡** 2 **≡**

	x	Freq
2	2	2
3	3	3
4	4	2
5	5	1

**AC** **OPTN** **▼** **2** (Variable) **1** ( $\bar{x}$ ) **≡**

3

**Ex 3:** To calculate the logarithmic regression correlation coefficients for the following paired-variable data and determine the regression formula:  $(x, y) = (20, 3150), (110, 7310), (200, 8800), (290, 9310)$ . Specify Fix 3 (three decimal places) for results.

**SHIFT** **MENU** (SETUP) **▼** **3** (Statistics) **2** (Off)

**SHIFT** **MENU** (SETUP) **3** (Number Format) **1** (Fix) **3**

**OPTN** **1** (Select Type) **4** ( $y=a+b \cdot \ln(x)$ )

20 **≡** 110 **≡** 200 **≡** 290 **≡** **▼** **▶**  
3150 **≡** 7310 **≡** 8800 **≡** 9310 **≡**

	x	y
2	110	7310
3	200	8800
4	290	9310
5		

**AC** **OPTN** **▼** **4** (Regression) **3** ( $r$ ) **≡**

0.998

**AC** **OPTN** **▼** **4** (Regression) **1** ( $a$ ) **≡**

-3857.984

**AC** **OPTN** **▼** **4** (Regression) **2** ( $b$ ) **≡**

2357.532

## Calculating Estimated Values

Based on the regression formula obtained by paired-variable statistical calculation, the estimated value of  $y$  can be calculated for a given  $x$ -value. The corresponding  $x$ -value (two values,  $x_1$  and  $x_2$ , in the case of quadratic regression) also can be calculated for a value of  $y$  in the regression formula.

**Ex 4:** To determine the estimate value for  $y$  when  $x = 160$  in the regression formula produced by logarithmic regression of the data in Ex 3. Specify Fix 3 for the result. (Perform the following operation after completing the operations in Ex 3.)

**AC** 160 **OPTN** **▼** **4** (Regression) **5** ( $\hat{y}$ ) **≡**

8106.898

**Important:** Regression coefficient, correlation coefficient, and estimated value calculations can take considerable time when there are a large number of data items.

## Performing Normal Distribution Calculations

While single-variable statistical calculation is selected, you can perform normal distribution calculation using the functions shown below from the menu that appears when you perform the following key operation:

**OPTN** **▼** **4** (Norm Dist).

**P, Q, R:** These functions take the argument  $t$  and determine a probability of standard normal distribution as illustrated nearby.

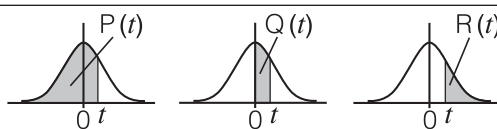

► $t$ : This function is preceded by the argument  $x$ . It calculates the standard variate for data value  $x$  using the mean value ( $\bar{x}$ ) and population standard deviation ( $\sigma_x$ ) of data input with Statistics Editor.

$$x \blacktriangleright t = \frac{x - \bar{x}}{\sigma_x}$$

**Ex 5:** For the single variable data in Ex 2, to determine the normalized variate when  $x = 2$ , and  $P(t)$  at that point.

**AC** **2** **OPTN** **▼** **4** (Norm Dist) **4** ( $\blacktriangleright t$ ) **≡**

**2**  $\blacktriangleright t$   
-0.8660254038

**OPTN** **▼** **4** (Norm Dist) **1** (P) **Ans** **1** **≡**

**P(Ans)**  
0.19324

## Base- $n$ Calculations

When you want to perform calculations using decimal, hexadecimal, binary, and/or octal values, enter the Base-N Mode. After entering the Base-N Mode, press one of the following keys to switch number modes:  **$x^2$**  (DEC) for decimal,  **$x^3$**  (HEX) for hexadecimal,  **$\log_{10}$**  (BIN) for binary, or  **$\ln$**  (OCT) for octal.

To calculate  $11_2 + 1_2$

**$\log_{10}$**  (BIN) **11** **+** **1** **≡**

**[Bin]**  
11+1  
0000 0000 0000 0000  
0000 0000 0000 0100

### Note

- Use the following keys to input the letters A through F for hexadecimal values:  **$\leftarrow$**  (A),  **$\circ\circ\circ$**  (B),  **$x^3$**  (C),  **$\sin$**  (D),  **$\cos$**  (E),  **$\tan$**  (F).
- In the Base-N Mode, input of fractional (decimal) values and exponents is not supported. If a calculation result has a fractional part, it is cut off.
- Details about input and output ranges (32 bits) are shown below.

<b>Binary</b>	Positive:	$00000000000000000000000000000000 \leq x \leq 01111111111111111111111111111111$
	Negative:	$10000000000000000000000000000000 \leq x \leq 11111111111111111111111111111111$
<b>Octal</b>	Positive:	$0000000000 \leq x \leq 1777777777$
	Negative:	$2000000000 \leq x \leq 3777777777$
<b>Decimal</b>		$-2147483648 \leq x \leq 2147483647$
<b>Hexadecimal</b>	Positive:	$00000000 \leq x \leq 7FFFFFFF$
	Negative:	$80000000 \leq x \leq FFFFFFFF$

## Specifying the Number Mode of a Particular Input Value

You can input a special command immediately following a value to specify the number mode of that value. The special commands are: d (decimal), h (hexadecimal), b (binary), and o (octal).

To calculate  $10_{10} + 10_{16} + 10_2 + 10_8$  and display the result as a decimal value

**AC**  **$x^2$**  (DEC) **OPTN** **▼** **1** (d) **10** **+** **OPTN** **▼** **2** (h) **10** **+**



## Converting a Calculation Result to another Type of Value

You can use any one of the following key operations to convert the currently displayed calculation result to another type of value:  $x^2$  (DEC),  $x^h$  (HEX),  $\log_a$  (BIN),  $\ln$  (OCT).

To calculate  $15_{10} \times 37_{10}$  in the decimal mode, and then convert the result to hexadecimal

AC  $x^2$  (DEC) 15  $\times$  37 ☰ 555  
 $x^h$  (HEX) 000022B

## Logical and Negation Operations

Logical and negation operations are performed by pressing OPTN and then selecting the desired command (and, or, xor, xnor, Not, Neg) from the menu that appears. All of the examples below are performed in the binary mode ( $\log_a$  (BIN)).

To determine the logical AND of  $1010_2$  and  $1100_2$  ( $1010_2$  and  $1100_2$ )

AC 1010 OPTN 3 (and) 1100 ☰ 0000 0000 0000 0000  
 0000 0000 0000 1000

To determine the bitwise complement of  $1010_2$  (Not( $1010_2$ ))

AC OPTN 2 (Not) 1010  $\square$  ☰ 1111 1111 1111 1111  
 1111 1111 1111 0101

**Note:** In the case of a negative binary, octal or hexadecimal value, the calculator converts the value to binary, takes the two's complement, and then converts back to the original number base. For decimal values, the calculator merely adds a minus sign.

## Equation Calculations

Perform the steps below to solve an equation in the Equation/Func Mode.

1. Press MENU, select the Equation/Func Mode icon, and then press ☰.
2. Select the type of calculation you want to perform.

To select this calculation type:	Do this:
Simultaneous linear equations with two, three, or four unknowns	Press 1 (Simul Equation), and then use a number key (2 to 4) to specify the number of unknowns.
Quadratic equations, cubic equations, or quartic equations	Press 2 (Polynomial), and then use a number key (2 to 4) to specify the polynomial degree.

3. Use the Coefficient Editor that appears to input coefficient values.
  - To solve  $2x^2 + x - 3 = 0$ , for example, press 2 (Polynomial) 2 in step 2. Use the Coefficient Editor that appears to input 2 ☰ 1 ☰ (-) 3 ☰.
  - Pressing AC will clear all of the coefficients to zero.
4. After all the values are the way you want, press ☰.

- This will display a solution. Each press of  $\boxed{\text{=}}$  will display another solution. Pressing  $\boxed{\text{=}}$  while the final solution is displayed will return to the Coefficient Editor.
- A message appears to let you know when there is no solution or when there are infinite solutions. Pressing  $\boxed{\text{AC}}$  or  $\boxed{\text{=}}$  will return to the Coefficient Editor.
- You can assign the currently displayed solution to a variable. While the solution is displayed, press  $\boxed{\text{STO}}$  and then the key that corresponds to the name of the variable to which you want to assign it.
- To return to the Coefficient Editor while any solution is displayed, press  $\boxed{\text{AC}}$ .

**Note:** Solutions that include  $\sqrt{\phantom{x}}$  are displayed only when the selected calculation type is Polynomial.

**To change the current equation type setting:** Press  $\boxed{\text{OPTN}} \boxed{1}$  (Simul Equation) or  $\boxed{\text{OPTN}} \boxed{2}$  (Polynomial), and then press  $\boxed{2}$ ,  $\boxed{3}$ , or  $\boxed{4}$ . Changing the equation type causes the values of all Coefficient Editor coefficients to change to zero.

## Equation/Func Mode Calculation Examples

$$x + 2y = 3, 2x + 3y = 4$$

$\boxed{\text{OPTN}} \boxed{1}$  (Simul Equation)  $\boxed{2}$

1  $\boxed{\text{=}}$  2  $\boxed{\text{=}}$  3  $\boxed{\text{=}}$  2  $\boxed{\text{=}}$  3  $\boxed{\text{=}}$  4  $\boxed{\text{=}}$

{	1x +	2y =	3
	2x +	3y =	4

(x=) -1  
(y=) 2

$$x^2 + 2x - 2 = 0$$

$\boxed{\text{OPTN}} \boxed{2}$  (Polynomial)  $\boxed{2}$

1  $\boxed{\text{=}}$  2  $\boxed{\text{=}}$   $\boxed{\leftarrow}$  2  $\boxed{\text{=}}$   $\boxed{\text{=}}$

(x<sub>1</sub>=)  $-1 + \sqrt{3}$   
(x<sub>2</sub>=)  $-1 - \sqrt{3}$

(Displays x-coordinate of local minimum of  $y = x^2 + 2x - 2$ .)

(x=) -1

(Displays y-coordinate of local minimum of  $y = x^2 + 2x - 2$ .)

(y=) -3

\* The x- and y-coordinates of the local minimum (or local maximum) of the function  $y = ax^2 + bx + c$  are also displayed, but only when a quadratic equation is selected for the calculation type.

## Matrix Calculations

Use the Matrix Mode to perform calculations involving matrices of up to 4 rows by 4 columns. To perform a matrix calculation, use the special matrix variables (MatA, MatB, MatC, MatD) as shown in the example below.

**Example:**  $\begin{bmatrix} 2 & 1 \\ 1 & 1 \end{bmatrix} \times \begin{bmatrix} 2 & -1 \\ -1 & 2 \end{bmatrix}$

1. Press  $\boxed{\text{MENU}}$ , select the Matrix Mode icon, and then press  $\boxed{\text{=}}$ .
2. Press  $\boxed{1}$  (MatA)  $\boxed{2}$  (2 rows)  $\boxed{2}$  (2 columns).

- This will display the Matrix Editor for input of the elements of the  $2 \times 2$  matrix you specified for MatA.

MatA=	$\begin{bmatrix} \text{0} & \text{0} \\ \text{0} & \text{0} \end{bmatrix}$
-------	--

3. Input the elements of MatA: 2  $\boxed{\text{=}}$  1  $\boxed{\text{=}}$  1  $\boxed{\text{=}}$  1  $\boxed{\text{=}}$ .

- Perform the following key operation:  $\text{OPTN}$   $\boxed{1}$  (Define Matrix)  $\boxed{2}$  (MatB)  $\boxed{2}$  (2 rows)  $\boxed{2}$  (2 columns).
- Input the elements of MatB:  $2$   $\text{=}$   $\text{↵}$   $1$   $\text{=}$   $\text{↵}$   $1$   $\text{=}$   $2$   $\text{=}$ .
- Press  $\text{AC}$  to advance to the calculation screen, and perform the calculation (MatA  $\times$  MatB):  $\text{OPTN}$   $\boxed{3}$  (MatA)  $\times$   $\text{OPTN}$   $\boxed{4}$  (MatB)  $\text{=}$ .
  - This will display the MatAns (Matrix Answer Memory) screen with the calculation results.

MatAns=	
$\begin{bmatrix} \text{E} & 0 \\ 1 & 1 \end{bmatrix}$	

## Matrix Answer Memory (MatAns)

Whenever the result of a calculation executed in the Matrix Mode is a matrix, the MatAns screen will appear with the result. The result also will be assigned to a variable named “MatAns”.

The MatAns variable can be used in calculations as described below.

- To insert the MatAns variable into a calculation, perform the following key operation:  $\text{OPTN}$   $\text{▼}$   $\boxed{1}$  (MatAns).
- Pressing any one of the following keys while the MatAns screen is displayed will switch automatically to the calculation screen:  $\text{+}$ ,  $\text{-}$ ,  $\times$ ,  $\text{÷}$ ,  $x^y$ ,  $x^2$ ,  $\text{SHIFT}$   $x^2$  ( $x^3$ ).

## Assigning and Editing Matrix Variable Data

### To assign new data to a matrix variable

- Press  $\text{OPTN}$   $\boxed{1}$  (Define Matrix), and then, on the menu that appears, select the matrix variable to which you want to assign data.
- On the dialog box that appears, use a number key ( $\boxed{1}$  to  $\boxed{4}$ ) to specify the number of rows.
- On the next dialog box that appears, use a number key ( $\boxed{1}$  to  $\boxed{4}$ ) to specify the number of columns.
- Use the Matrix Editor that appears to input the elements of the matrix.

### To edit the elements of a matrix variable

Press  $\text{OPTN}$   $\boxed{2}$  (Edit Matrix), and then, on the menu that appears, select the matrix variable you want to edit.

### To copy matrix variable (or MatAns) contents

- Use the Matrix Editor to display the matrix you want to copy.
  - If you want to copy MatAns contents, perform the following to display the MatAns screen:  $\text{OPTN}$   $\text{▼}$   $\boxed{1}$  (MatAns)  $\text{=}$ .
- Press  $\text{STO}$ , and then perform one of the following key operations to specify the copy destination:  $\text{↵}$  (MatA),  $\text{''''}$  (MatB),  $x^y$  (MatC), or  $\text{sin}$  (MatD).
  - This will display the Matrix Editor with the contents of the copy destination.

## Matrix Calculation Examples

The following examples use  $\text{MatA} = \begin{bmatrix} 2 & 1 \\ 1 & 1 \end{bmatrix}$ ,  $\text{MatB} = \begin{bmatrix} 1 & 0 & -1 \\ 0 & -1 & 1 \end{bmatrix}$ .

To obtain the determinant of MatA (Det(MatA))

$$\text{AC } \text{OPTN} \text{▼} \boxed{2} \text{ (Determinant) } \text{MatA} \boxed{)} \text{=}$$

To create a  $2 \times 2$  identity matrix and add it to MatA (Identity(2) + MatA)

$$\text{AC } \text{OPTN} \text{▼} \boxed{4} \text{ (Identity) } \boxed{2} \boxed{)} \text{+ } \text{MatA} \text{=}$$

$\begin{bmatrix} \text{E} & 0 \\ 1 & 1 \end{bmatrix}$	$\begin{bmatrix} 1 & 0 \\ 0 & 1 \end{bmatrix}$
---	--

**Note:** You can specify a value from 1 to 4 as the Identity command argument (number of dimensions).

To obtain the transposition of MatB (Trn(MatB))

$$\boxed{\text{AC}} \boxed{\text{OPTN}} \boxed{\blacktriangledown} \boxed{3} (\text{Transposition}) \text{MatB} \boxed{)} \boxed{=} \begin{bmatrix} \blacksquare & 0 \\ 0 & -1 \\ -1 & 1 \end{bmatrix}$$

To invert, square, and cube MatA ( $\text{MatA}^{-1}$ ,  $\text{MatA}^2$ ,  $\text{MatA}^3$ )

**Note:** You cannot use  $\boxed{x^a}$  for this input. Use  $\boxed{x^{-1}}$  to input “-1”,  $\boxed{x^2}$  to specify squaring, and  $\boxed{\text{SHIFT}} \boxed{x^2}$  ( $x^3$ ) to specify cubing.

$$\boxed{\text{AC}} \text{MatA} \boxed{x^{-1}} \boxed{=} \begin{bmatrix} \blacksquare & -1 \\ -1 & 2 \end{bmatrix}$$

$$\boxed{\text{AC}} \text{MatA} \boxed{x^2} \boxed{=} \begin{bmatrix} \blacksquare & 3 \\ 3 & 2 \end{bmatrix}$$

$$\boxed{\text{AC}} \text{MatA} \boxed{\text{SHIFT}} \boxed{x^2} (x^3) \boxed{=} \begin{bmatrix} \blacksquare & 8 \\ 8 & 5 \end{bmatrix}$$

To obtain the absolute value of each element of MatB ( $\text{Abs}(\text{MatB})$ )

$$\boxed{\text{AC}} \boxed{\text{SHIFT}} \boxed{\text{[ ]}} (\text{Abs}) \text{MatB} \boxed{)} \boxed{=} \begin{bmatrix} \blacksquare & 0 & 1 \\ 0 & 1 & 1 \end{bmatrix}$$

## Creating a Number Table

The Table Mode generates a number table based on one or two functions.

**Example:** To generate a number table for the functions  $f(x) = x^2 + \frac{1}{2}$  and  $g(x) = x^2 - \frac{1}{2}$  for the range  $-1 \leq x \leq 1$ , incremented in steps of 0.5

1. Press  $\boxed{\text{MENU}}$ , select the Table Mode icon, and then press  $\boxed{=}$ .
2. Configure settings to generate a number table from two functions.

$$\boxed{\text{SHIFT}} \boxed{\text{MENU}} (\text{SETUP}) \boxed{\blacktriangledown} \boxed{\blacktriangledown} \boxed{2} (\text{Table}) \boxed{2} (f(x), g(x))$$

3. Input  $x^2 + \frac{1}{2}$ .

$$\boxed{\text{ALPHA}} \boxed{)} (x) \boxed{x^2} \boxed{+} 1 \boxed{=} 2$$

$$f(x) = x^2 + \frac{1}{2}$$

4. Input  $x^2 - \frac{1}{2}$ .

$$\boxed{=} \boxed{\text{ALPHA}} \boxed{)} (x) \boxed{x^2} \boxed{-} 1 \boxed{=} 2$$

$$g(x) = x^2 - \frac{1}{2}$$

5. Press  $\boxed{=}$ . On the Table Range dialog box that appears, input values for Start (Default: 1), End (Default: 5), and Step (Default: 1).

$$\boxed{\leftarrow} 1 \boxed{=} 1 \boxed{=} 0.5 \boxed{=}$$

Table Range  
Start: -1  
End: 1  
Step: 0.5

6. Press  $\boxed{=}$  to generate the number table.

- Press  $\boxed{\text{AC}}$  to return to the screen in step 3.

	x	f(x)	g(x)
1	-1	1.5	0.5
2	-0.5	0.75	-0.25
3	0	0.5	-0.5
4	0.5	0.75	-0.25

### Tip

- In the number table shown in step 6, you can change the value in the currently highlighted  $x$  cell. Changing the  $x$  value causes the  $f(x)$  and  $g(x)$  values in the same line to be updated accordingly.
- If there is value in the  $x$  cell above the currently highlighted  $x$  cell, pressing  $\boxed{+}$  or  $\boxed{=}$  automatically inputs into the highlighted cell the value equal to the value of the cell above it plus the step value. So also,

pressing  $\square$  automatically inputs the value equal to the value of the cell above less the step value. The  $f(x)$  and  $g(x)$  values in the same line are also updated accordingly.

### Note

- After pressing  $\square$  in step 4 above, proceeding from step 5 onwards without inputting anything for  $g(x)$  will generate a number table for  $f(x)$  only.
- The maximum number of rows in the generated number table depends on the setup menu table setting. Up to 45 rows are supported for the “ $f(x)$ ” setting, while 30 rows are supported for the “ $f(x),g(x)$ ” setting.
- The number table generation operation causes the contents of variable  $x$  to be changed.

**Important:** Functions input in this mode are deleted whenever the Input/Output settings are changed in the Table Mode.

## Vector Calculations

Use the Vector Mode to perform 2-dimensional and 3-dimensional vector calculations. To perform a vector calculation, use the special vector variables (VctA, VctB, VctC, VctD) as shown in the example below.

**Example:**  $(1, 2) + (3, 4)$

1. Press  $\square$ , select the Vector Mode icon, and then press  $\square$ .
2. Press  $\square$  (VctA)  $\square$  (2 dimensions).

- This will display the Vector Editor for input of the 2-dimensional vector for VctA.



3. Input the elements of VctA:  $\square$   $\square$ .
4. Perform the following key operation:  $\square$   $\square$  (Define Vector)  $\square$  (VctB)  $\square$  (2 dimensions).
5. Input the elements of VctB:  $\square$   $\square$ .
6. Press  $\square$  to advance to the calculation screen, and perform the calculation (VctA + VctB):  $\square$   $\square$  (VctA)  $\square$   $\square$  (VctB)  $\square$ .

- This will display the VctAns (Vector Answer Memory) screen with the calculation results.



## Vector Answer Memory

Whenever the result of a calculation executed in the Vector Mode is a vector, the VctAns screen will appear with the result. The result also will be assigned to a variable named “VctAns”.

The VctAns variable can be used in calculations as described below.

- To insert the VctAns variable into a calculation, perform the following key operation:  $\square$   $\square$  (VctAns).
- Pressing any one of the following keys while the VctAns screen is displayed will switch automatically to the calculation screen:  $\square$ ,  $\square$ ,  $\square$ ,  $\square$ .

## Assigning and Editing Vector Variable Data

**To assign new data to a vector variable**

1. Press  $\square$   $\square$  (Define Vector), and then, on the menu that appears, select the vector variable to which you want to assign data.
2. On the dialog box that appears, press  $\square$  or  $\square$  to specify the vector dimension.

3. Use the Vector Editor that appears to input the elements of the vector.

### To edit the elements of a vector variable

Press **OPTN** **2** (Edit Vector), and then, on the menu that appears, select the vector variable you want to edit.

### To copy vector variable (or VctAns) contents

- Use the Vector Editor to display the vector you want to copy.
  - If you want to copy VctAns contents, perform the following to display the VctAns screen: **OPTN** **▼** **1** (VctAns) **≡**.
- Press **STO**, and then perform one of the following key operations to specify the copy destination: **←** (VctA), **⋮** (VctB), **⊗** (VctC), or **sin** (VctD).
  - This will display the Vector Editor with the contents of the copy destination.

## Vector Calculation Examples

The examples below use VctA = (1, 2) and VctB = (3, 4), and VctC = (2, -1, 2).

VctA • VctB (Vector dot product)

$$\boxed{\text{AC}} \text{ VctA } \boxed{\text{OPTN}} \text{ ▼ } \boxed{2} \text{ (Dot Product) VctB } \boxed{\equiv} \quad \boxed{\text{VctA} \cdot \text{VctB}} \quad 11$$

VctA × VctB (Vector cross product)

$$\boxed{\text{AC}} \text{ VctA } \boxed{\otimes} \text{ VctB } \boxed{\equiv} \quad \boxed{\begin{bmatrix} 0 \\ 0 \\ -2 \end{bmatrix}}$$

To obtain the absolute values of VctC

$$\boxed{\text{AC}} \boxed{\text{SHIFT}} \boxed{[ ]} \text{ (Abs) VctC } \boxed{[ ]} \boxed{\equiv} \quad \boxed{\text{Abs(VctC)}} \quad 3$$

To determine the angle formed by VctA and VctB to three decimal places (Fix 3). (Angle Unit: Degree)

$$\boxed{\text{SHIFT}} \boxed{\text{MENU}} \text{ (SETUP) } \boxed{3} \text{ (Number Format) } \boxed{1} \text{ (Fix) } \boxed{3} \\ \boxed{\text{AC}} \text{ OPTN } \text{ ▼ } \boxed{3} \text{ (Angle) VctA } \boxed{\text{SHIFT}} \boxed{[ ]} \text{ (,)} \\ \text{VctB } \boxed{[ ]} \boxed{\equiv} \quad \boxed{\text{Angle(VctA, VctB)}} \quad 10.305$$

To normalize VctB

$$\boxed{\text{AC}} \text{ OPTN } \text{ ▼ } \boxed{4} \text{ (Unit Vector) VctB } \boxed{[ ]} \boxed{\equiv} \quad \boxed{\begin{bmatrix} 0.8 \\ 0.8 \end{bmatrix}}$$

## Inequality Calculations

You can use the procedure below to solve a 2nd, 3rd, or 4th degree inequality.

- Press **MENU**, select the Inequality Mode icon, and then press **≡**.
- On the dialog box that appears, use a number key (**2** to **4**) to specify the degree of the inequality.
- On the menu that appears, use keys **1** through **4** to select the inequality symbol type and orientation.
- Use the Coefficient Editor that appears to input coefficient values.
  - To solve  $x^2 + 2x - 3 < 0$ , for example, input the following for the coefficients ( $a = 1$ ,  $b = 2$ ,  $c = -3$ ): **1** **≡** **2** **≡** **←** **3** **≡**.
  - Pressing **AC** will clear all of the coefficients to zero.
- After all the values are the way you want, press **≡**.
  - This will display the solutions.

- To return to the Coefficient Editor while the solutions are displayed, press **AC**.

**To change the Inequality Type:** Pressing **OPTN** **1** (Polynomial) displays a dialog box that you can use to select an inequality degree. Changing the degree of an inequality causes the values of all Coefficient Editor coefficients to become zero.

## Inequality Mode Calculation Examples

$$3x^3 + 3x^2 - x > 0$$

**OPTN** **1** (Polynomial) **3** (3<sup>rd</sup> degree inequality) **1** ( $ax^3+bx^2+cx+d>0$ )

3 **□** 3 **□** (-) 1 **□**

$ax^3+bx^2+cx+d>0$			
$3x^3+$	$3x^2-$	$1x$	
$> 0$			

**□** **□** **□** **□**

$\frac{-3-\sqrt{21}}{6} < x < 0,$	$\frac{-3+\sqrt{21}}{6} < x$
-----------------------------------	------------------------------

### Note

- Solutions are displayed as shown in the screen shot nearby when something other than MathI/MathO is selected for the Input/Output setting on the setup menu.
- “All Real Numbers” appears on the solution screen when the solution of an inequality is all numbers (such as  $x^2 \geq 0$ ).
- “No Solution” appears on the solution screen when no solution exists for an inequality (such as  $x^2 < 0$ ).

$a < x < b, c < x$	
a=	-1.263762616
b=	0
c=	0.2637626158

## Ratio Calculations

The Ratio Mode lets you determine the value of X in the ratio expression  $A : B = X : D$  (or  $A : B = C : X$ ) when the values of A, B, C and D are known. The following shows the general procedure for using Ratio.

- Press **MENU**, select the Ratio Mode icon, and then press **□**.
- On the menu that appears, select **1** (A:B=X:D) or **2** (A:B=C:X).
- On the Coefficient Editor screen that appears, input up to 10 digits for each of the required values (A, B, C, D).
  - To solve  $3 : 8 = X : 12$  for X, for example, press **1** in step 1, and then input the following for the coefficients (A = 3, B = 8, D = 12):  
3 **□** 8 **□** 12 **□**.
  - Pressing **AC** will reset all of the coefficients to one.
- After all the values are the way you want, press **□**.
  - This displays the solution (value of X). Pressing **□** again will return to the Coefficient Editor.

**Important:** A Math ERROR will occur if you perform a calculation while 0 is input for a coefficient.

To calculate X in the ratio  $1 : 2 = X : 10$

**OPTN** **1** (Select Type) **1** (A:B=X:D)

1 **□** 2 **□** 10 **□**

___ 1 :	___ 2 =	X: <b>□</b> <b>□</b>
---------	---------	----------------------

**□**

(X=) 5

## Changing the Ratio Expression Type

Press **OPTN** **1** (Select Type) and then select the ratio expression type you want from the menu that appears.

# Distribution Calculations

You can use the procedures below to perform seven different types of distribution calculations.

1. Press **MENU**, select the Distribution Mode icon, and then press **≡**.
2. On the menu that appears, select a distribution calculation type.

To select this calculation type:	Press this key:
Normal probability density	<b>1</b> (Normal PD)
Normal cumulative distribution	<b>2</b> (Normal CD)
Inverse normal cumulative distribution	<b>3</b> (Inverse Normal)
Binomial probability	<b>4</b> (Binomial PD)
Binomial cumulative distribution	<b>▼ 1</b> (Binomial CD)
Poisson probability	<b>▼ 2</b> (Poisson PD)
Poisson cumulative distribution	<b>▼ 3</b> (Poisson CD)

- If you selected Normal PD, Normal CD, or Inverse Normal as the calculation type, go to step 4 of this procedure. For any other calculation type, go to step 3.
3. On the dialog box that appears, select a data ( $x$ ) input method.
    - To input multiple  $x$  data items at the same time, press **1** (List). To input a single data item, press **2** (Variable).
    - If you selected **1** (List) above, a list screen will appear at this time so you can input the  $x$  data items.
  4. Input values for the variables.
    - The variables that require data input depend on the calculation type you selected in step 2 of this procedure.
  5. After inputting values for all of the variables, press **≡**.
    - This displays the calculation results.
    - Pressing **≡** while a calculation result is displayed will return to the variable input screen.

## Note

- If you selected something other than “List” in step 3 of this procedure the calculation result will be stored in Ans memory.
- Distribution calculation accuracy is up to six significant digits.

**To change the distribution calculation type:** Press **OPTN 1** (Select Type) and then select the distribution type you want.

## Variables that Accept Input

Distribution calculation variables that accept input values are those below.

Normal PD:  $x$ ,  $\sigma$ ,  $\mu$

Normal CD: Lower, Upper,  $\sigma$ ,  $\mu$

Inverse Normal: Area,  $\sigma$ ,  $\mu$  (Tail setting always left.)

Binomial PD, Binomial CD:  $x$ ,  $N$ ,  $p$

Poisson PD, Poisson CD:  $x$ ,  $\lambda$

$x$ : data,  $\sigma$ : standard deviation ( $\sigma > 0$ ),  $\mu$ ,  $\lambda$ : mean, Lower: lower boundary, Upper: upper boundary, Area: probability value ( $0 \leq \text{Area} \leq 1$ ),  $N$ : number of trials,  $p$ : success probability ( $0 \leq p \leq 1$ )



## List Screen

You can input up to 45 data samples for each variable. Calculation results are also displayed on the List Screen.

- (1) Distribution calculation type
- (2) Value at current cursor position
- (3) Data ( $x$ )
- (4) Calculation results ( $P$ )

1	$x$	1	0.0286	Binomial PD
2		2	0.0779	
3		3	0.1385	
4		4	0.1809	

(1)  
(2)

(3)      (4)

**To edit data:** Move the cursor to the cell that contains the data you want to edit, input the new data, and then press  $\boxed{\text{=}}$ .

**To delete data:** Move the cursor to the data you want to delete and then press  $\boxed{\text{DEL}}$ .

**To insert data:** Move the cursor to the position where you want to insert the data, press  $\boxed{\text{OPTN}} \boxed{2}$  (Editor)  $\boxed{1}$  (Insert Row), and then input the data.

**To delete all data:** Press  $\boxed{\text{OPTN}} \boxed{2}$  (Editor)  $\boxed{2}$  (Delete All).

## Distribution Mode Calculation Examples

To calculate the normal probability density when  $x = 36$ ,  $\sigma = 2$ ,  $\mu = 35$

1. Perform the key operation below to select Normal PD.

$\boxed{\text{OPTN}} \boxed{1}$  (Select Type)  $\boxed{1}$  (Normal PD)

- This displays the variable input screen.

Normal PD	
$x$	:0
$\sigma$	:1
$\mu$	:0

2. Input values for  $x$ ,  $\sigma$ , and  $\mu$ .  $36 \boxed{\text{=}} 2 \boxed{\text{=}} 35 \boxed{\text{=}}$

3. Press  $\boxed{\text{=}}$ .

- This displays the calculation results. ( $p$ =) 0.1760326634
- Pressing  $\boxed{\text{=}}$  again or pressing  $\boxed{\text{AC}}$  returns to the variable input screen in step 1 of this procedure.

**Note:** You can assign the currently displayed solution to a variable. While the solution is displayed, press  $\boxed{\text{STO}}$  and then the key that corresponds to the name of the variable to which you want to assign it.

To calculate binomial probability for the data {10, 11, 12, 13} when  $N = 15$  and  $p = 0.6$

1. Perform the key operation below to select Binomial PD.

$\boxed{\text{OPTN}} \boxed{1}$  (Select Type)  $\boxed{4}$  (Binomial PD)

2. Because you want to input four data ( $x$ ) values, press  $\boxed{1}$  (List) here.

- This displays the List Screen.

3. Input a value for  $x$ .  $10 \boxed{\text{=}} 11 \boxed{\text{=}} 12 \boxed{\text{=}} 13 \boxed{\text{=}}$

4. After inputting all of the values, press  $\boxed{\text{=}}$ .

- This displays the variable input screen.

5. Input values for  $N$  and  $p$ .  $15 \boxed{\text{=}} 0.6 \boxed{\text{=}}$

6. Press  $\boxed{\text{=}}$ .

- This returns to the List Screen, with the calculation result for each  $x$  value shown in the  $P$  column.

	$x$		$P$	Binomial PD
1	10		0.1859	
2	11		0.1267	
3	12		0.0633	
4	13		0.0219	

Pressing  $\boxed{\text{=}}$  returns to the variable input screen in step 4 of this procedure.

### Note

- Changing any  $x$  value in step 6 of the above procedure will clear all calculation results and return to step 2. In this case, all of the other  $x$  values (except for the one you changed), and the values assigned to

variables  $N$  and  $p$  remain the same. This means you can repeat a calculation changing only one specific value.

- On the List Screen, you can assign the value in a cell to a variable. Move the cell cursor to cell that contains the value you want to assign, press **[STO]**, and then press the key that corresponds to the desired variable name.
- An error message appears if the input value is outside the allowable range. "ERROR" will appear in the P column of the Result Screen when the value input for the corresponding data is outside the allowable range.

## Using Spreadsheet

To perform the operations in this section, first enter the Spreadsheet Mode.

The Spreadsheet Mode makes it possible to perform calculations using a 45-row  $\times$  5-column (cell A1 to E45) spreadsheet.

(1) Row numbers (1 to 45)

(2) Column letters (A to E)

(3) Cell cursor: Indicates the currently selected cell.

(4) Edit box: Shows the contents of the cell where the cell cursor is currently located.

The diagram shows a 4x4 grid with columns labeled A, B, C, D and rows labeled 1, 2, 3, 4. The values in the cells are: A1: 170, B1: 179, C1: 176, D1: 176; A2: 173, B2: 175, C2: 171, D2: 182; A3: 177, B3: 175, C3: 175, D3: 177; A4: 520. A cell cursor is positioned at cell A4. An edit box below the grid displays the formula `=Sum(A1:A3)`. Labels (1) through (4) point to the row numbers, column letters, cell cursor, and edit box respectively.

**Important:** Any time you exit the Spreadsheet Mode, turn off the calculator or press the **[ON]** key, every input into the spreadsheet is cleared.

## Inputting and Editing Cell Contents

You can input a constant or a formula into each cell.

**Constants:** A constant is something whose value is fixed as soon as you finalize its input. A constant can be either a numeric value, or a calculation formula (such as  $7+3$ ,  $\sin 30$ ,  $A1 \times 2$ , etc.) that does not have an equal sign (=) in front of it.

**Formula:** A formula that starts out with an equal sign (=), such as  $=A1 \times 2$ , is executed as it is written.

**Note:** Up to 10 bytes can be input into each cell in the case of a constant. In the case of a formula, you can input up to 49 bytes into each cell.

Inputting a formula into a cell requires 11 bytes in addition to the number of bytes for the actual formula data.

**To display the remaining input capacity:** Press **[OPTN]** **[4]** (Free Space).

**To input a constant and/or formula into a cell**

**Ex 1:** Into cells A1, A2, and A3, input constants  $7 \times 5$ ,  $7 \times 6$ , and  $A2+7$  respectively. And then, input the following formula into cell B1:  $=A1+7$ .

1. Move the cell cursor to cell A1.

2. Perform the key operation below.

**7** **[ $\times$ ]** **5** **[=]** **7** **[ $\times$ ]** **6** **[=]** **[ALPHA]** **[ $\leftarrow$ ]** **(A)** **2** **[+]** **7** **[=]**

3. Move the cell cursor to cell B1, and then perform the key operation below.

**[ALPHA]** **[CALC]** **(=)** **[ALPHA]** **[ $\leftarrow$ ]** **(A)** **1** **[+]** **7** **[=]**

The diagram shows a 4x4 grid with columns labeled A, B, C, D and rows labeled 1, 2, 3, 4. The values in the cells are: A1: 35, B1: 42, A2: 42, A3: 49. The cell cursor is positioned at cell B1.

**Note:** You can specify whether a formula in the edit box should be displayed as it is or as its calculation result value.

## To edit existing cell data

1. Move the cell cursor to the cell whose contents you want to edit, and then press **OPTN** **3** (Edit Cell).
  - Cell contents in the edit box will change from align right to align left. A text cursor will appear in the edit box so you can edit its contents.
2. Use **▶** and **◀** to move the cursor around the contents of the cell, and edit them as required.
3. To finalize and apply your edits, press **≡**.

## To input a cell reference name using the Grab command

The Grab command can be used in place of manual reference name (such as A1) input using a key operation to select and input a cell you want to reference.

**Ex 2:** Continuing from Ex 1, input the following formula into cell B2: =A2+7.

1. Move the cell cursor to cell B2.
2. Perform the key operation below.

**ALPHA** **CALC** (=) **OPTN** **2** (Grab) **◀**

	A	B	C	D
1	35	42		
2	42			
3	49			
4				

Set: [=]

**≡** **+** 7 **≡**

	A	B	C	D
1	35	42		
2	42	49		
3	49			
4				

## Cell Relative and Absolute References

There are two types of cell reference: relative and absolute.

**Relative cell reference:** The cell reference (A1) in a formula like =A1+7 is a relative reference, which means that it changes depending on the cell where the formula is located. If the formula =A1+7 is originally located in cell B1, for example, copying and then pasting to cell C3 will result in =B3+7 being input into cell C3. Since the copy and paste operation moves the formula one column (B to C) and two rows (1 to 3) causes the A1 relative cell reference in the formula to change to B3. If the result of a copy and paste operation causes a relative cell reference name to change to something that is outside the range of the spreadsheet cells, the applicable column letter and/or row number will be replaced by a question mark (?), and "ERROR" will be displayed as the cell's data.

**Absolute cell reference:** If you want the row or the column, or both the row and the column parts of a cell reference name to remain the same no matter where you paste them, you need to create an absolute cell reference name. To create an absolute cell reference put a dollar sign (\$) in front of the column name and/or row number. You can use one of three different absolute cell references: absolute column with relative row (\$A1), relative column with absolute row (A\$1), or absolute row and column (\$A\$1).

## To input the absolute cell reference symbol (\$)

While inputting a formula into a cell, press **OPTN** **1** (\$).

## To cut and paste spreadsheet data

1. Move the cursor to the cell whose data you want to cut and then press **OPTN** **▼** **1** (Cut & Paste).
  - This enters paste standby. To cancel paste standby, press **AC**.
2. Move the cursor to the cell into which you want to paste the data you just cut, and then press **≡**.

- Pasting data simultaneously deletes the data from the cell where you performed the cut operation, and automatically cancels paste standby.

**Note:** In the case of a cut and paste operation, cell references do not change when pasted, regardless of whether they are relative or absolute.

### To copy and paste spreadsheet data

1. Move the cursor to the cell whose data you want to copy and then press **OPTN** **▼** **2** (Copy & Paste).
  - This enters paste standby. To cancel paste standby, press **AC**.
2. Move the cursor to the cell into which you want to paste the data you just copied, and then press **≡**.
  - Paste standby remains enabled until you press **AC**, so you can paste the copied data to other cells, if you want.

**Note:** When you copy the contents of a cell that contains a formula with a relative reference, the relative reference will change in accordance with the location of the cell where the contents are pasted.

### To delete input data from a specific cell

Move the cell cursor to the cell whose contents you want to delete and then press **DEL**.

### To delete the contents of all the cells in a spreadsheet

Press **OPTN** **▼** **3** (Delete All).

## Using Variables (A, B, C, D, E, F, M, x, y)

You can use **STO** to assign the value of a cell to a variable. You can also use **SHIFT** **STO** (RECALL) to input the value assigned to a variable into a cell.

## Using Spreadsheet Mode Special Commands

In the Spreadsheet Mode, the commands below can be used inside formulas or constants. These command are on the menu that appears when you press **OPTN**.

Min(	Returns the minimum of the values in a specified range of cells. Syntax: Min(start cell:end cell)
Max(	Returns the maximum of the values in a specified range of cells. Syntax: Max(start cell:end cell)
Mean(	Returns the mean of the values in a specified range of cells. Syntax: Mean(start cell:end cell)
Sum(	Returns the sum of the values in a specified range of cells. Syntax: Sum(start cell:end cell)

**Ex 3:** Continuing from Ex 1, input the formula =Sum(A1:A3), which calculates the sum of cells A1, A2, and A3, into cell A4.

1. Move the cell cursor to cell A4.
2. Input =Sum(A1:A3).

**ALPHA** **CALC** (=) **OPTN** **▼** **4** (Sum)  
**ALPHA** **(←)** (A) **1** **ALPHA** **⌵** (:)  
**ALPHA** **(←)** (A) **3** **)**

	A	B	C	D
1	35	42		
2	42			
3	49			
4	=Sum(A1:A3)			

3. Press **≡**.

	A	B	C	D
2	42			
3	49			
4	126			

# Batch Inputting the Same Formula or Constant into Multiple Cells

You can use the procedures in this section to input the same formula or constant into a specific series of cells. Use the Fill Formula command to batch input a formula, or Fill Value to batch input a constant.

**Note:** If the input formula or constant includes a relative reference, the relative reference will be input in accordance with the upper left cell of the specified range. If the input formula or constant includes an absolute reference, the absolute reference will be input into all of the cells in the specified range.

## To batch input the same formula into a series of cells

**Ex 4:** Continuing from Ex 1, batch input into cells B1, B2, and B3 a formula that doubles the value of the cell to the left and then subtracts 3.

1. Move the cell cursor to cell B1.
2. Press **OPTN** **1** (Fill Formula).
  - This displays a Fill Formula dialog box.
3. In the “Form” row, input the formula “=2A1-3”: **2** **ALPHA** **(←)** **(A)** **1** **=** **3** **≡**.
  - Input of the equals symbol (=) at the beginning is not required.
4. Move the highlighting to the “Range” line and specify B1:B3 as the range of the batch input.

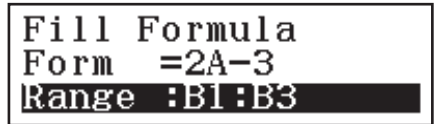

5. To apply the input, press **≡**.
  - This inputs =2A1-3 into cell B1, =2A2-3 into cell B2, and =2A3-3 into cell B3.

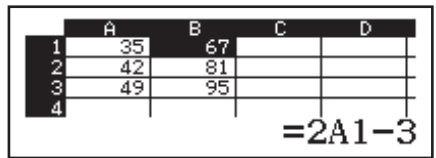

## To batch input the same constant into a series of cells

**Ex 5:** Continuing from Ex 4, batch input into cells C1, C2, and C3 the values that are triple those of the cells to the left.

1. Move the cell cursor to cell C1.
2. Press **OPTN** **2** (Fill Value).
  - This displays a Fill Value dialog box.
3. In the “Value” line, input the constant B1×3: **ALPHA** **(\*)** **(B)** **1** **×** **3** **≡**.
4. Move the highlighting to the “Range” line and specify C1:C3 as the range of the batch input.



5. To apply the input, press **≡**.
  - This inputs the values of each calculation result into cells C1, C2, and C3.

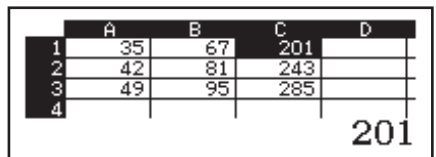

# Recalculation

Auto Calc is a setup item. Depending on the content of the spreadsheet, auto recalculation can take a long time to complete. When Auto Calc is disabled (Off), you need to execute recalculation manually as required.

**To perform recalculation manually:** Press **OPTN** **(▼)** **4** (Recalculate).

## Scientific Constants

Your calculator comes with 47 built-in scientific constants.

**Example:** To input the scientific constant  $c_0$  (speed of light in a vacuum), and display its value

1. Press **AC** **SHIFT** **7** (CONST) to display a menu of scientific constant categories.

```
1:Universal
2:Electromagnetic
3:Atomic&Nuclear
4:Physico-Chem
```

2. Press **1** (Universal) to display a menu of scientific constants in the Universal category.

```
1:h      2:t      3:c0
4:ε0     5:μ0     6:Z0
7:G      8:1p     9:tp
```

3. Press **3** ( $c_0$ ) **▢**.

299792458

- The values are based on CODATA (2010) recommended values.

## Metric Conversion

You can use the metric conversion commands to convert from one unit of measurement to another.

**Example:** To convert 5 cm into inches (LineI/LineO)

1. Input the value to be converted and display the metric conversion menu.

**AC** 5 **SHIFT** **8** (CONV)

```
1:Length
2:Area
3:Volume
4:Mass
```

2. On the conversion category menu that appears, select “Length”.

**1** (Length)

```
1:in>cm      2:cm>in
3:ft>m       4:m>ft
5:yd>m       6:m>yd
7:mile>km    8:km>mile
9:n mile>m   A:m>n mile
B:pc>km      C:km>pc
```

3. Select the centimeters-to-inches conversion command and then perform the conversion.

**2** (cm>in) **▢**

```
5cm>in
1.968503937
```

### Note

- Conversion formula data is based on the “NIST Special Publication 811 (2008)”.
- The **J▶cal** command performs conversion for values at a temperature of 15°C.

## Errors

The calculator will display an error message whenever an error occurs for any reason during a calculation. While an error message is displayed, press **◀** or **▶** to return to the calculation screen. The cursor will be positioned at the location where the error occurred, ready for input.

**To clear the error message:** While an error message is displayed, press **AC** to return to the calculation screen. Note that this also clears the calculation that contained the error.

# Error Messages

---

## Math ERROR

- The intermediate or final result of the calculation you are performing exceeds the allowable calculation range.
  - Your input exceeds the allowable input range (particularly when using functions).
  - The calculation you are performing contains an illegal mathematical operation (such as division by zero).
- Check the input values, reduce the number of digits, and try again.
- When using independent memory or a variable as the argument of a function, make sure that the memory or variable value is within the allowable range for the function.
- 

## Stack ERROR

- The calculation you are performing has caused the capacity of the numeric stack or the command stack to be exceeded.
  - The calculation you are performing has caused the capacity of the matrix or vector stack to be exceeded.
- Simplify the calculation expression so it does not exceed the capacity of the stack.
- Try splitting the calculation into two or more parts.
- 

## Syntax ERROR

- There is a problem with the format of the calculation you are performing.
- 

## Argument ERROR

- There is a problem with the argument of the calculation you are performing.
- 

## Dimension ERROR (Matrix and Vector Modes only)

- The matrix or vector you are trying to use in a calculation was input without specifying its dimension.
  - You are trying to perform a calculation with matrices or vectors whose dimensions do not allow that type of calculation.
- Specify the dimension of the matrix or vector and then perform the calculation again.
- Check the dimensions specified for the matrices or vectors to see if they are compatible with the calculation.
- 

## Variable ERROR (SOLVE feature only)

- An attempt to execute SOLVE for an expression input without any variable included.
- Input an expression that includes a variable.
- 

## Cannot Solve (SOLVE feature only)

- The calculator could not obtain a solution.
- Check for errors in the equation that you input.
- Input a value for the solution variable that is close to the expected solution and try again.
- 

## Range ERROR

- An attempt to generate a number table in the Table Mode whose conditions cause it to exceed the maximum number of allowable rows.
  - During batch input in the Spreadsheet Mode, input for Range is outside the allowable range or is a cell name that does not exist.
- Narrow the table calculation range by changing the Start, End, and Step values, and try again.
- For Range, input a cell name within the range of A1 through E45, using the syntax: "A1:A1".
- 

## Time Out

- The current differential or integration calculation ends without the ending condition being fulfilled.
- Try increasing the *tol* value. Note that this also decreases solution precision.

---

### Circular ERROR (Spreadsheet Mode only)

- There is a circular reference (such as “=A1” in cell A1) in the spreadsheet.
- Change cell contents to remove the circular references.

---

### Memory ERROR (Spreadsheet Mode only)

- You are attempting to input data that exceeds the allowable input capacity (1,700 bytes).
  - You are attempting to input data that results in a chain of consecutive cell references (such as cell A2 referenced from cell A1, cell A3 referenced from cell A2..., etc.) This type of input always causes this error to be generated, even if memory capacity (1,700 bytes) is not exceeded.
  - Memory capacity was exceeded because a formula that includes a relative cell reference was copied, or because of batch input of formulas that use relative cell references.
- Delete unneeded data and input data again.
- Minimize input that results in a chain of consecutive cell references.
- Shorten the formula being copied or the formulas being batch input.
- 

## Before Assuming Malfunction of the Calculator...

Note that you should make separate copies of important data before performing these steps.

1. Check the calculation expression to make sure that it does not contain any errors.
2. Make sure that you are using the correct mode for the type of calculation you are trying to perform.
3. If the above steps do not correct your problem, press the **ON** key.
  - This will cause the calculator to perform a routine that checks whether calculation functions are operating correctly. If the calculator discovers any abnormality, it automatically initializes the calculation mode and clears memory contents.
4. Return the calculation mode and setup (except for the Contrast setting) to their initial default settings by performing the following operation:  
**SHIFT** **9** (RESET) **1** (Setup Data) **≡** (Yes).

## Replacing the Battery

A low battery is indicated by a dim display, even if contrast is adjusted, or by failure of figures to appear on the display immediately after you turn on the calculator. If this happens, replace the battery with a new one.

**Important:** Removing the battery will cause all of the calculator's memory contents to be deleted.



1. Press **SHIFT** **AC** (OFF) to turn off the calculator.

- To ensure that you do not accidentally turn on power while replacing the battery, slide the hard case onto the front of the calculator.

2. As shown in the illustration, remove the cover, remove the battery, and then load a new battery with its plus (+) and minus (-) ends facing correctly.

3. Replace the cover.

4. Initialize the calculator: **ON** **SHIFT** **9** (RESET) **3** (Initialize All) **≡** (Yes).

- Do not skip the above step!

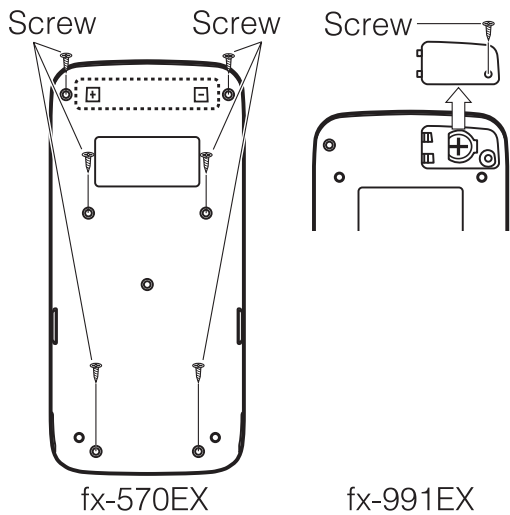

## Technical Information

### Calculation Range and Precision

Calculation Range	$\pm 1 \times 10^{-99}$ to $\pm 9.999999999 \times 10^{99}$ or 0
Number of Digits for Internal Calculation	15 digits
Precision	In general, $\pm 1$ at the 10th digit for a single calculation. Precision for exponential display is $\pm 1$ at the least significant digit. Errors are cumulative in the case of consecutive calculations.

### Function Calculation Input Ranges and Precision

Functions	Input Range	
$\sin x$ $\cos x$	Degree	$0 \leq  x  < 9 \times 10^9$
	Radian	$0 \leq  x  < 157079632.7$
	Gradian	$0 \leq  x  < 1 \times 10^{10}$
$\tan x$	Degree	Same as $\sin x$ , except when $ x  = (2n-1) \times 90$ .
	Radian	Same as $\sin x$ , except when $ x  = (2n-1) \times \pi/2$ .
	Gradian	Same as $\sin x$ , except when $ x  = (2n-1) \times 100$ .
$\sin^{-1}x, \cos^{-1}x$	$0 \leq  x  \leq 1$	
$\tan^{-1}x$	$0 \leq  x  \leq 9.999999999 \times 10^{99}$	
$\sinh x, \cosh x$	$0 \leq  x  \leq 230.2585092$	
$\sinh^{-1}x$	$0 \leq  x  \leq 4.999999999 \times 10^{99}$	
$\cosh^{-1}x$	$1 \leq x \leq 4.999999999 \times 10^{99}$	

$\tanh x$	$0 \leq  x  \leq 9.999999999 \times 10^{99}$
$\tanh^{-1}x$	$0 \leq  x  \leq 9.999999999 \times 10^{-1}$
$\log x, \ln x$	$0 < x \leq 9.999999999 \times 10^{99}$
$10^x$	$-9.999999999 \times 10^{99} \leq x \leq 99.999999999$
$e^x$	$-9.999999999 \times 10^{99} \leq x \leq 230.2585092$
$\sqrt{x}$	$0 \leq x < 1 \times 10^{100}$
$x^2$	$ x  < 1 \times 10^{50}$
$x^{-1}$	$ x  < 1 \times 10^{100}; x \neq 0$
$\sqrt[3]{x}$	$ x  < 1 \times 10^{100}$
$x!$	$0 \leq x \leq 69$ ( $x$ is an integer)
$nPr$	$0 \leq n < 1 \times 10^{10}, 0 \leq r \leq n$ ( $n, r$ are integers) $1 \leq \{n!/(n-r)!\} < 1 \times 10^{100}$
$nCr$	$0 \leq n < 1 \times 10^{10}, 0 \leq r \leq n$ ( $n, r$ are integers) $1 \leq n!/r! < 1 \times 10^{100}$ or $1 \leq n!/(n-r)! < 1 \times 10^{100}$
$\text{Pol}(x, y)$	$ x ,  y  \leq 9.999999999 \times 10^{99}$ $\sqrt{x^2 + y^2} \leq 9.999999999 \times 10^{99}$
$\text{Rec}(r, \theta)$	$0 \leq r \leq 9.999999999 \times 10^{99}$ $\theta$ : Same as $\sin x$
o' "	$ a , b, c < 1 \times 10^{100}; 0 \leq b, c$ The display seconds value is subject to an error of $\pm 1$ at the second decimal place.
↔ o' "	$ x  < 1 \times 10^{100}$ Decimal ↔ Sexagesimal Conversions $0^\circ 0' 0'' \leq  x  \leq 99999999^\circ 59' 59''$
$x^y$	$x > 0: -1 \times 10^{100} < y \log x < 100$ $x = 0: y > 0$ $x < 0: y = n, \frac{m}{2n+1}$ ( $m, n$ are integers) However: $-1 \times 10^{100} < y \log  x  < 100$
$\sqrt[x]{y}$	$y > 0: x \neq 0, -1 \times 10^{100} < 1/x \log y < 100$ $y = 0: x > 0$ $y < 0: x = 2n+1, \frac{2n+1}{m}$ ( $m \neq 0; m, n$ are integers) However: $-1 \times 10^{100} < 1/x \log  y  < 100$
$a^{b/c}$	Total of integer, numerator, and denominator must be 10 digits or less (including separator symbol).
$\text{RanInt}\#(a, b)$	$a < b;  a ,  b  < 1 \times 10^{10}; b - a < 1 \times 10^{10}$

- Precision is basically the same as that described under “Calculation Range and Precision”, above.
- $x^y$ ,  $\sqrt[x]{y}$ ,  $\sqrt[3]{y}$ ,  $x!$ ,  $nPr$ ,  $nCr$  type functions require consecutive internal calculation, which can cause accumulation of errors that occur with each calculation.
- Error is cumulative and tends to be large in the vicinity of a function’s singular point and inflection point.
- The range for calculation results that can be displayed in  $\pi$  form when MathI/MathO is selected for Input/Output on the setup menu is  $|x| < 10^6$ . Note, however, that internal calculation error can make it impossible to display some calculation results in  $\pi$  form. It also can cause calculation results that should be in decimal form to appear in  $\pi$  form.

## Specifications

### Power Requirements:

fx-570EX: AAA-size battery R03 (UM-4)  $\times$  1

fx-991EX: Built-in solar cell; button battery LR44  $\times$  1

### Approximate Battery Life:

2 years (based on one hour of operation per day)

### Power Consumption: 0.0006 W (fx-570EX)

### Operating Temperature: 0°C to 40°C (32°F to 104°F)

### Dimensions:

fx-570EX: 13.8 (H)  $\times$  77 (W)  $\times$  165.5 (D) mm  
 $\frac{1}{2}$ " (H)  $\times$  3" (W)  $\times$  6 $\frac{1}{2}$ " (D)

fx-991EX: 11.1 (H)  $\times$  77 (W)  $\times$  165.5 (D) mm  
 $\frac{3}{8}$ " (H)  $\times$  3" (W)  $\times$  6 $\frac{1}{2}$ " (D)

### Approximate Weight:

fx-570EX: 100 g (3.5 oz) including the battery

fx-991EX: 90 g (3.2 oz) including the battery

## ■ Frequently Asked Questions ■

### How can I change a fraction form result produced by a division operation to decimal form?

→ While a fraction calculation result is displayed, press  $\boxed{\text{S}\rightarrow\text{D}}$ . To have calculation results initially appear as decimal values, change the setup menu Input/Output setting to MathI/DecimalO.

### What is the difference between Ans memory, independent memory, and variable memory?

→ Each of these types of memory acts like “containers” for temporary storage of a single value.

**Ans Memory:** Stores the result of the last calculation performed. Use this memory to carry the result of one calculation on to the next.

**Independent Memory:** Use this memory to totalize the results of multiple calculations.

**Variables:** This memory is helpful when you need to use the same value multiple times in one or more calculations.

### What is the key operation to take me from the Statistics Mode or Table Mode to a mode where I can perform arithmetic calculations?

→ Press  $\boxed{\text{MENU}}$   $\boxed{1}$  (Calculate).

### How can I return the calculator to its initial default settings?

→ Perform the following operation to initialize calculator settings (except the Contrast setting):  $\boxed{\text{SHIFT}}$   $\boxed{9}$  (RESET)  $\boxed{1}$  (Setup Data)  $\boxed{\text{=}}$  (Yes).

**When I execute a function calculation, why do I get a calculation result that is completely different from older CASIO calculator models?**

→ With a Natural Textbook Display model, the argument of a function that uses parentheses must be followed by a closing parenthesis. Failing to press  $\text{)}\text{}$  after the argument to close the parentheses may cause unwanted values or expressions to be included as part of the argument.

---

Example:  $(\sin 30) + 15$  (Angle Unit: Degree)

Older (S-V.P.A.M.) Model:

$$\boxed{\sin} 30 \boxed{+} 15 \boxed{=} 15.5$$

Natural Textbook Display Model:  
(LineI/LineO)

$$\boxed{\sin} 30 \boxed{)} \boxed{+} 15 \boxed{=} 15.5$$

Failure to press  $\text{)}\text{}$  here as shown below will result in calculation of  $\sin 45$ .

$$\boxed{\sin} 30 \boxed{+} 15 \boxed{=} 0.7071067812$$

---

# Reference Sheet

## Scientific Constants **SHIFT** **7** (CONST)

<b>1</b> (Universal)	<b>1</b> : $h$	<b>2</b> : $\hbar$	<b>3</b> : $c_0$
	<b>4</b> : $\epsilon_0$	<b>5</b> : $\mu_0$	<b>6</b> : $Z_0$
	<b>7</b> : $G$	<b>8</b> : $l_p$	<b>9</b> : $t_p$
<b>2</b> (Electromagnetic)	<b>1</b> : $\mu_N$	<b>2</b> : $\mu_B$	<b>3</b> : $e$
	<b>4</b> : $\phi_0$	<b>5</b> : $G_0$	<b>6</b> : $K_J$
	<b>7</b> : $R_K$		
<b>3</b> (Atomic&Nuclear)	<b>1</b> : $m_p$	<b>2</b> : $m_n$	<b>3</b> : $m_e$
	<b>4</b> : $m_\mu$	<b>5</b> : $a_0$	<b>6</b> : $\alpha$
	<b>7</b> : $r_e$	<b>8</b> : $\lambda_C$	<b>9</b> : $\gamma_p$
	<b>A</b> : $\lambda_{Cp}$	<b>B</b> : $\lambda_{Cn}$	<b>C</b> : $R_\infty$
	<b>D</b> : $\mu_p$	<b>E</b> : $\mu_e$	<b>F</b> : $\mu_n$
	<b>M</b> : $\mu_\mu$	<b>X</b> : $m_t$	
<b>4</b> (Physico-Chem)	<b>1</b> : $u$	<b>2</b> : $F$	<b>3</b> : $N_A$
	<b>4</b> : $k$	<b>5</b> : $V_m$	<b>6</b> : $R$
	<b>7</b> : $C_1$	<b>8</b> : $C_2$	<b>9</b> : $\sigma$
<b>1</b> (Adopted Values)	<b>1</b> : $g$	<b>2</b> : atm	<b>3</b> : $R_{K-90}$
	<b>4</b> : $K_{J-90}$		
<b>2</b> (Other)	<b>1</b> : $t$		

## Metric Conversion **SHIFT** **8** (CONV)

<b>1</b> (Length)	<b>1</b> : in $\blacktriangleright$ cm	<b>2</b> : cm $\blacktriangleright$ in
	<b>3</b> : ft $\blacktriangleright$ m	<b>4</b> : m $\blacktriangleright$ ft
	<b>5</b> : yd $\blacktriangleright$ m	<b>6</b> : m $\blacktriangleright$ yd
	<b>7</b> : mile $\blacktriangleright$ km	<b>8</b> : km $\blacktriangleright$ mile
	<b>9</b> : n mile $\blacktriangleright$ m	<b>A</b> : m $\blacktriangleright$ n mile
	<b>B</b> : pc $\blacktriangleright$ km	<b>C</b> : km $\blacktriangleright$ pc
<b>2</b> (Area)	<b>1</b> : acre $\blacktriangleright$ m <sup>2</sup>	<b>2</b> : m <sup>2</sup> $\blacktriangleright$ acre
<b>3</b> (Volume)	<b>1</b> : gal(US) $\blacktriangleright$ L	<b>2</b> : L $\blacktriangleright$ gal(US)
	<b>3</b> : gal(UK) $\blacktriangleright$ L	<b>4</b> : L $\blacktriangleright$ gal(UK)
<b>4</b> (Mass)	<b>1</b> : oz $\blacktriangleright$ g	<b>2</b> : g $\blacktriangleright$ oz
	<b>3</b> : lb $\blacktriangleright$ kg	<b>4</b> : kg $\blacktriangleright$ lb
<b>1</b> (Velocity)	<b>1</b> : km/h $\blacktriangleright$ m/s	<b>2</b> : m/s $\blacktriangleright$ km/h
<b>2</b> (Pressure)	<b>1</b> : atm $\blacktriangleright$ Pa	<b>2</b> : Pa $\blacktriangleright$ atm
	<b>3</b> : mmHg $\blacktriangleright$ Pa	<b>4</b> : Pa $\blacktriangleright$ mmHg
	<b>5</b> : kgf/cm <sup>2</sup> $\blacktriangleright$ Pa	<b>6</b> : Pa $\blacktriangleright$ kgf/cm <sup>2</sup>
	<b>7</b> : lbf/in <sup>2</sup> $\blacktriangleright$ kPa	<b>8</b> : kPa $\blacktriangleright$ lbf/in <sup>2</sup>
<b>3</b> (Energy)	<b>1</b> : kgf $\cdot$ m $\blacktriangleright$ J	<b>2</b> : J $\blacktriangleright$ kgf $\cdot$ m
	<b>3</b> : J $\blacktriangleright$ cal	<b>4</b> : cal $\blacktriangleright$ J
<b>4</b> (Power)	<b>1</b> : hp $\blacktriangleright$ kW	<b>2</b> : kW $\blacktriangleright$ hp
<b>1</b> (Temperature)	<b>1</b> : $^{\circ}$ F $\blacktriangleright$ $^{\circ}$ C	<b>2</b> : $^{\circ}$ C $\blacktriangleright$ $^{\circ}$ F

# CASIO®



Manufacturer:  
CASIO COMPUTER CO., LTD.  
6-2, Hon-machi 1-chome  
Shibuya-ku, Tokyo 151-8543, Japan

Responsible within the European Union:  
CASIO EUROPE GmbH  
Casio-Platz 1  
22848 Norderstedt, Germany



This mark applies in EU countries only.

SA1412-A

Printed in China



© 2015 CASIO COMPUTER CO., LTD.